

ioLogik E1200 Series User Manual

Version 16.1, April 2024

www.moxa.com/products

MOXA®

© 2024 Moxa Inc. All rights reserved.

ioLogik E1200 Series User Manual

The software described in this manual is furnished under a license agreement and may be used only in accordance with the terms of that agreement.

Copyright Notice

© 2024 Moxa Inc. All rights reserved.

Trademarks

The MOXA logo is a registered trademark of Moxa Inc.
All other trademarks or registered marks in this manual belong to their respective manufacturers.

Disclaimer

- Information in this document is subject to change without notice and does not represent a commitment on the part of Moxa.
- Moxa provides this document as is, without warranty of any kind, either expressed or implied, including, but not limited to, its particular purpose. Moxa reserves the right to make improvements and/or changes to this manual, or to the products and/or the programs described in this manual, at any time.
- Information provided in this manual is intended to be accurate and reliable. However, Moxa assumes no responsibility for its use, or for any infringements on the rights of third parties that may result from its use.
- This product might include unintentional technical or typographical errors. Changes are periodically made to the information herein to correct such errors, and these changes are incorporated into new editions of the publication.

Technical Support Contact Information

www.moxa.com/support

Table of Contents

1. Introduction	6
Product Features	6
Package Contents	6
Product Model Information	7
Product Specifications	7
Physical Dimensions	8
Hardware Reference	9
Panel Guide	9
Ethernet Port	9
LED Indicators	9
I/O Circuit Diagrams	10
DI Circuit	10
Sinking DO Circuit	10
Sourcing DO Circuit	11
DIO Circuit	12
Relay Circuit	13
AI Circuit	13
AO Circuit	13
RTD Circuit	14
TC Circuit	14
2. Initial Setup	15
Hardware Installation	15
Mounting	16
Grounding the Unit	18
I/O Channel Jumper Setting	18
I/O Wiring	20
Communication Port Wiring	24
Use the Cable Tie Base to Securely Route a Connected I/O Cable	25
Powering Up the Unit	26
ioSearch™ Installation	27
Load Factory Default Settings	27
3. Using the Web Console	28
Introduction to the Web Console	28
Overview	29
Network Settings for the Web Console	30
General Settings	30
Ethernet Configuration	30
User-defined Modbus Addressing	31
Default Modbus Address	31
AOPC Server Settings	32
Tag Generation	32
I/O Settings	34
DI Channels	34
DO Channels	37
AI Channels	38
AI Input Range	40
AO Channels	42
RTD Channels	43
TC Channels	44
Peer-to-Peer Networking	46
Peer-to-Peer Settings (1-50)	46
Sample Peer-to-peer Configuration	47
DO Safe Mode Settings	48
AO Safe Mode Settings	48
SNMP	49
SNMP Trap	49
Using SNMP	50
RESTful API Setting	54

EtherNet/IP Setting.....	55
System Management.....	55
Accessibility IP List	55
Password and Login Policy	56
Notification Message	57
Network Connection.....	57
Firmware Update.....	58
Import System Configuration Settings	58
Export System Settings.....	58
Change Password	59
Load Factory Defaults.....	59
Save/Restart.....	59
4. Using ioSearch™	60
Introduction to ioSearch™	60
ioSearch™ Main Screen	60
Main Screen Overview.....	60
ioSearch™ Setup	61
System	61
Sort.....	62
Quick Links.....	62
Main Function.....	63
Locate.....	63
Firmware Upgrade.....	63
Unlock	64
Import	64
Export.....	65
Change IP Address	65
Batch TCP/IP Configuration on Multiple Devices.....	66
Change Server Name.....	66
Activate EtherNet/IP	67
Restart System	67
Reset to Default	68
Mass Deployment (Import).....	68
Mass Deployment (Export)	68
5. Activating the EtherNet/IP Function	69
6. How to Connect the ioLogik E1200 to an Allen-Bradley PLC.....	73
EDS Installation of the ioLogik E1200 Series in Rockwell Software RSLogix 5000	73
Establishing communication between the ioLogik E1200 device and the Allen-Bradley PLC	77
7. RESTful API Implementation	82
Introduction.....	82
Configuring RESTful API Settings	82
Using RESTful API via a Web Service.....	83
Troubleshooting Reference.....	85
A. Modbus/TCP Default Address Mappings	86
Supported Function Code.....	86
ioLogik E1210 Modbus Address and Register Map	86
ioLogik E1211 Modbus Address and Register Map	87
ioLogik E1212 Modbus Address and Register Map	89
ioLogik E1213 Modbus Address and Register Map	91
ioLogik E1214 Modbus Address and Register Map	93
ioLogik E1240 Modbus Address and Register Map	95
ioLogik E1241 Modbus Address and Register Map	96
ioLogik E1242 Modbus Address and Register Map	98
ioLogik E1260 Modbus Address and Register Map	100
ioLogik E1262 Modbus Address and Register Map	101
B. EtherNet/IP Default Address Mappings	103
ioLogik E1200 EtherNet/IP Map	103
C. RESTful API Default Address Mappings.....	107
ioLogik E1200 RESTful API Map	107

D.	Network Port Numbers	111
E.	Factory Default Settings	112
F.	Pinouts	113
G.	FCC Interference Statement	114
H.	European Community (CE).....	115
I.	Firmware Update Guidelines.....	116

1. Introduction

The ioLogik E1200 industrial Ethernet remote I/O has two embedded Ethernet switch ports that allow information to flow to another local Ethernet device or connect to the next ioLogik in a daisy-chain. Applications such as factory automation, security, and surveillance systems, and tunnel monitoring can make use of daisy-chained Ethernet for building multidrop I/O networks over standard Ethernet cables and familiar fieldbus protocols. The daisy-chain function on the ioLogik E1200 Ethernet remote I/O not only increases the connections between machines and panels, but it also lowers the cost of buying separate Ethernet switches, while significantly reducing labor fees and cabling. For example, if a production facility contains 700 stations (20 points per station), the wiring cost reduction can reach 15% of the total implementation cost.

Product Features

- Active communication with patented MX-AOPC UA Server
- 2-port Ethernet switch for daisy-chain topologies
- Easy mass deployment and configuration with the ioSearch™ utility
- User-friendly configuration via web browser
- Save time and wiring costs with peer-to-peer communication
- User-defined Modbus/TCP addressing
- Simplify I/O management with MXIO library on either Windows or Linux platform
- Wide operating temperature: -40 to 75°C (-40 to 167°F)
- Supports SNMPv1/v2c
- UL/cUL Class I Division 2, ATEX Zone 2 certification

Package Contents

The ioLogik E1200 is shipped with the following items:

- ioLogik E1200 remote Ethernet I/O server
- Quick installation guide (printed)



NOTE

Notify your sales representative if any of the above items are missing or damaged.

Product Model Information

Model	Description
ioLogik E1210	Remote Ethernet I/O with 2-port Ethernet switch and 16 DIs
ioLogik E1211	Remote Ethernet I/O with 2-port Ethernet switch and 16 DOs
ioLogik E1212	Remote Ethernet I/O with 2-port Ethernet switch, 8 DIs, and 8 DIOs
ioLogik E1213	Remote Ethernet I/O with 2-port Ethernet switch, 8 DIs, 4 DOs, and 4 DIOs (source type)
ioLogik E1214	Remote Ethernet I/O with 2-port Ethernet switch, 6 DIs, and 6 relays
ioLogik E1240	Remote Ethernet I/O with 2-port Ethernet switch and 8 AIs
ioLogik E1241	Remote Ethernet I/O with 2-port Ethernet switch and 4 AOs
ioLogik E1242	Remote Ethernet I/O with 2-port Ethernet switch and 4 AIs, 4DIs, and 4DIOs
ioLogik E1260	Remote Ethernet I/O with 2-port Ethernet switch and 6 RTDs
ioLogik E1262	Remote Ethernet I/O with 2-port Ethernet switch and 8 TCs
ioLogik E1210-T	Ethernet remote I/O with 2-port Ethernet switch and 16 DIs, -40 to 75°C operating temperature
ioLogik E1211-T	Ethernet remote I/O with 2-port Ethernet switch and 16 DOs, -40 to 75°C operating temperature
ioLogik E1212-T	Ethernet remote I/O with 2-port Ethernet switch, 8 DIs, and 8 DIOs, -40 to 75°C operating temperature
ioLogik E1213-T	Remote Ethernet I/O with 2 Port Ethernet switch, 8 DIs, 4 DOs, and 4 DIOs (source type), -40 to 75°C operating temperature
ioLogik E1214-T	Ethernet remote I/O with 2-port Ethernet switch, 6 DIs, and 6 Relays, -40 to 75°C operating temperature
ioLogik E1240-T	Ethernet remote I/O with 2-port Ethernet switch and 8 AIs, -40 to 75°C operating temperature
ioLogik E1241-T	Ethernet remote I/O with 2-port Ethernet switch and 4 AOs, -40 to 75°C operating temperature
ioLogik E1242-T	Ethernet remote I/O with 2-port Ethernet switch, 4 AIs, 4 DIs, and 4 DIOs, -40 to 75°C operating temperature
ioLogik E1260-T	Ethernet remote I/O with 2-port Ethernet switch and 6 RTDs, -40 to 75°C operating temperature
ioLogik E1262-T	Ethernet remote I/O with 2-port Ethernet switch and 8 TCs, -40 to 75°C operating temperature

Product Specifications



NOTE

The latest specifications for Moxa's products can be found at <https://www.moxa.com>.

Physical Dimensions

Unit: mm (inch)

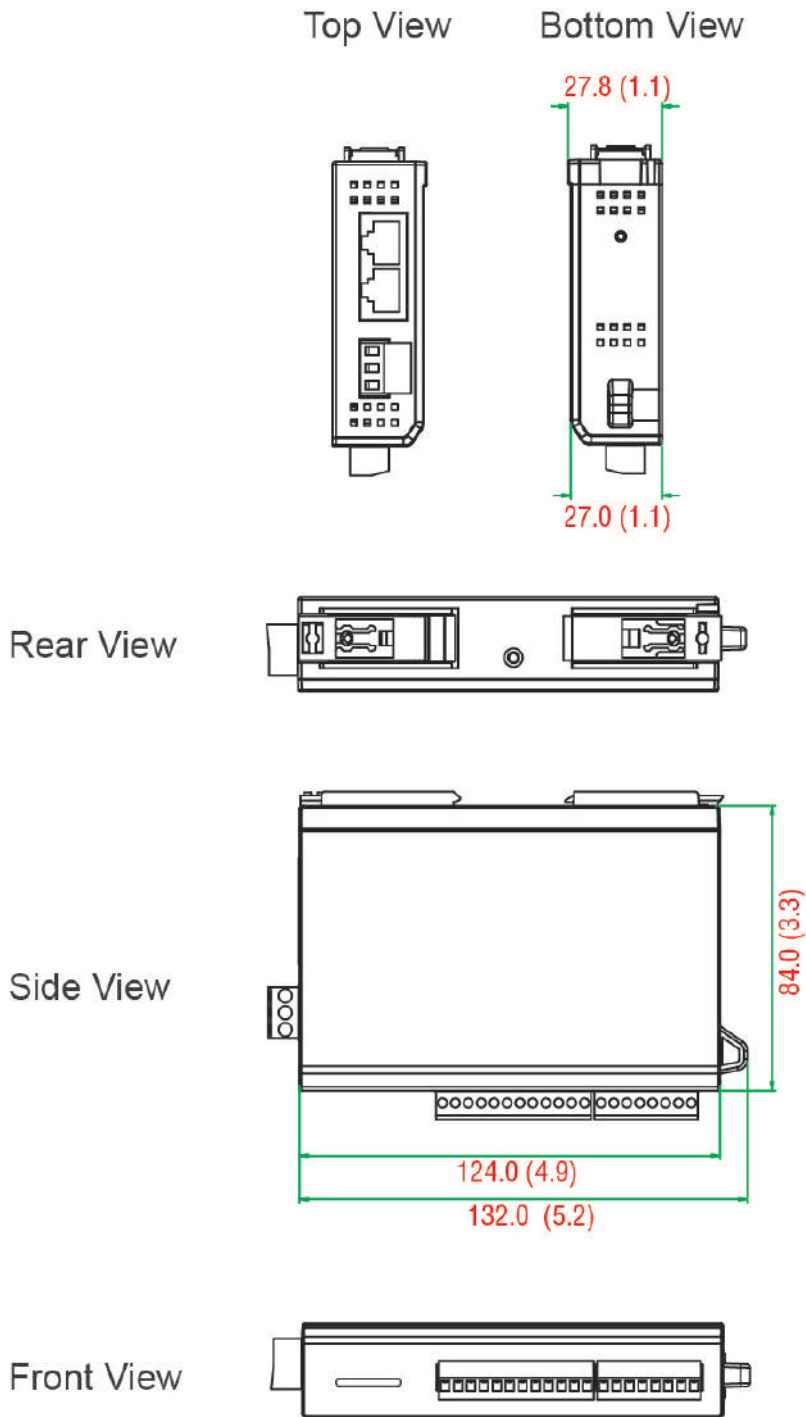

Hardware Reference

Panel Guide

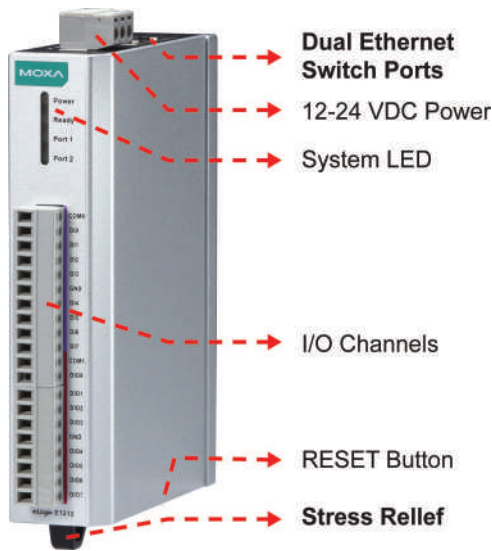

NOTE

The RESET button restarts the server and resets all settings to factory defaults. Use a pointed object such as a straightened paper clip to hold down the RESET button for 5 seconds. The factory defaults will be loaded once the READY LED turns green again. You may then release the RESET button.

Ethernet Port

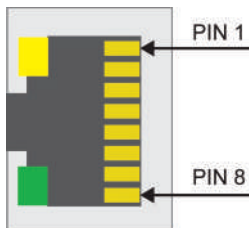

Pin	1	2	3	4
Signal	TXD+	TXD-	RXD+	-

Pin	5	6	7	8
Signal	-	RXD-	-	-

LED Indicators

LED	State	Description
Power	Amber	System power is ON
	OFF	System power is OFF
Ready	Green	System is ready
	Flashing	Flashes every 1 second when the "Locate" function is triggered
	Flashing	Flashes every 0.5 second when the firmware is being upgraded
	Flashing	ON/OFF cycle period of 0.5 second represents "Safe Mode"
	OFF	System is not ready
Port 1	Green	Ethernet connection enabled
	Flashing	Transmitting or receiving data
Port 2	Green	Ethernet connection enabled
	Flashing	Transmitting or receiving data
EXT	Green	EXT field power input is connected
	Off	EXT field power input is disconnected

DIO Circuit

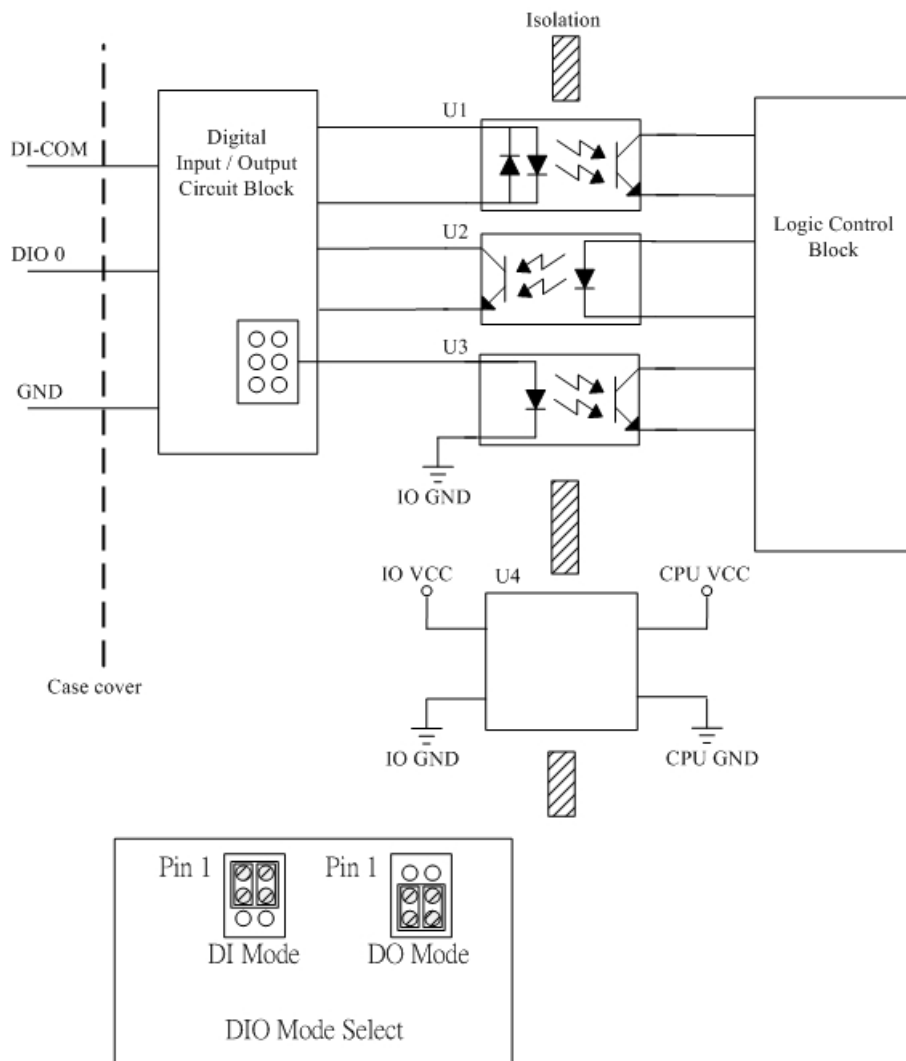

Relay Circuit

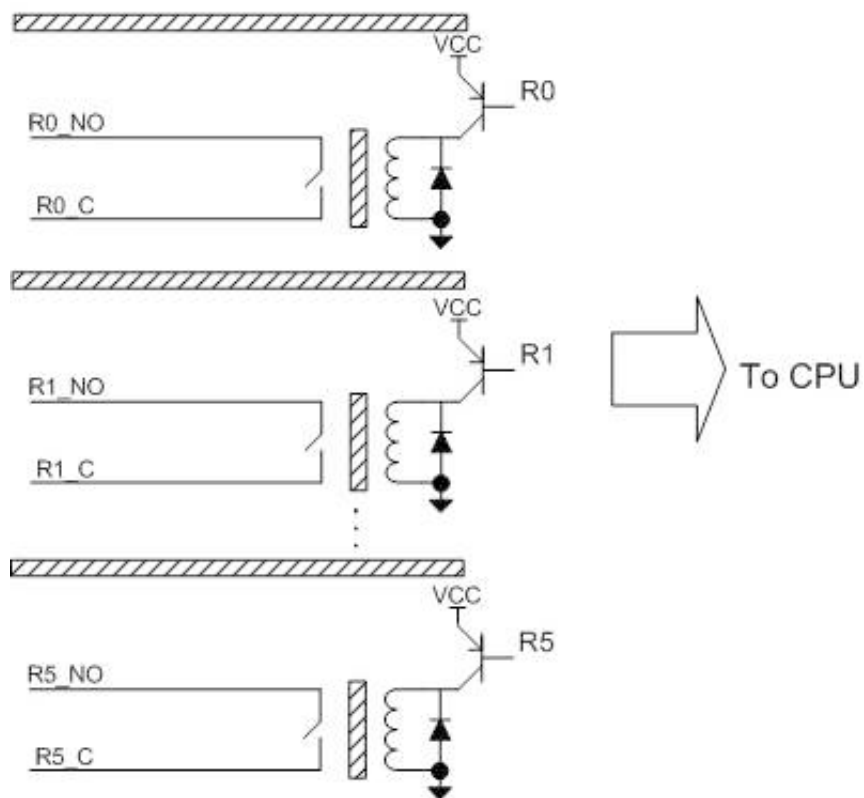

AI Circuit

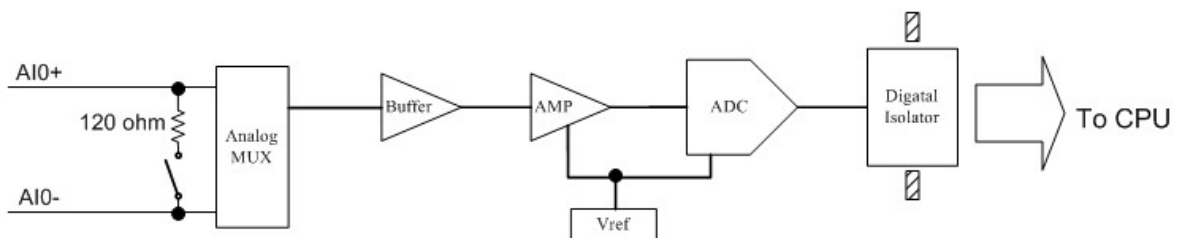

AO Circuit

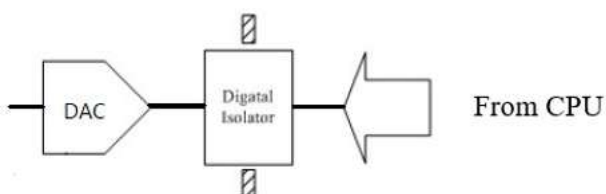

RTD Circuit

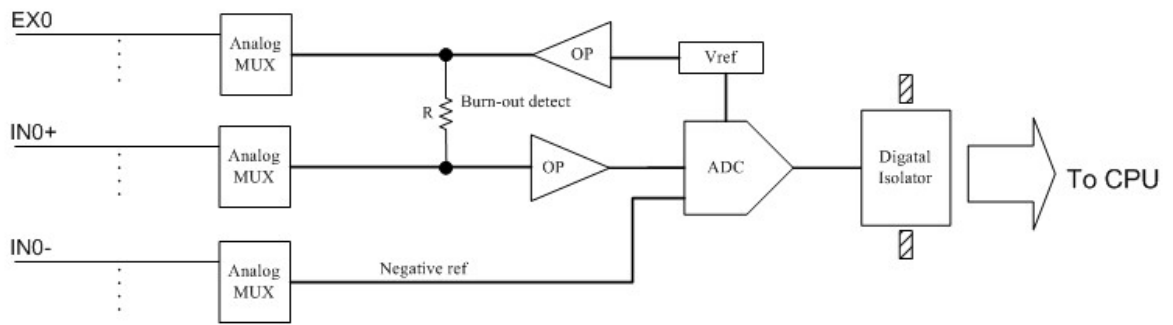

TC Circuit

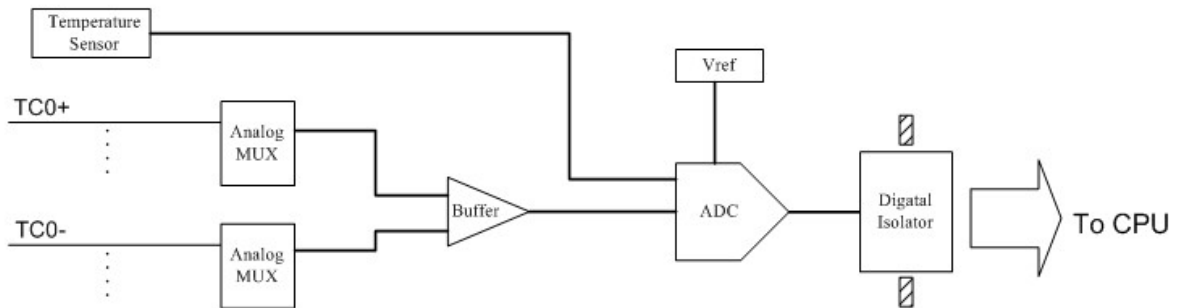

2. Initial Setup

This chapter describes how to install the ioLogik E1200.

Hardware Installation

Read all of the safety notifications and warnings below before installing the product.



ATTENTION

This unit is sensitive to Electrostatic Discharge, which can cause internal damage and affect normal operation. Follow these guidelines when you handle this unit:

- Before handling the product, touch a grounded object to discharge static electricity from your body.
- Wear an approved grounding wristband.
- Do not touch connectors or pins on component boards.
- Do not touch circuit components inside the equipment.
- Use a static-safe workstation, if available.
- Store the equipment in static-safe packaging when not in use.



WARNING

Disconnect the power when you want to remove or replace components or disconnect equipment, unless the area is free of ignitable material.

- If you connect or disconnect the Removable Terminal Block while field power is applied to the product, an electrical arc could occur. The arc could cause an explosion in hazardous location installations. Make sure the power is disconnected, or the area is nonhazardous before starting the installation process.
- If you connect or disconnect wiring while the field-side power is applied to the product, an electrical arc could occur. The arc could cause an explosion in hazardous location installations. Make sure the power is disconnected or the area is nonhazardous before starting the installation process.
- Do not disconnect the unit unless the power has been disconnected or the area is nonhazardous. In a hazardous area, the unit must be powered down before removal.

Mounting

The unit supports two types of mounting: DIN-rail mounting and Wall mounting. While mounting the unit, be sure to use the correct tools and accessories to ensure that the unit is properly mounted.

DIN Rail

Take the following steps to mount the unit on a DIN rail:

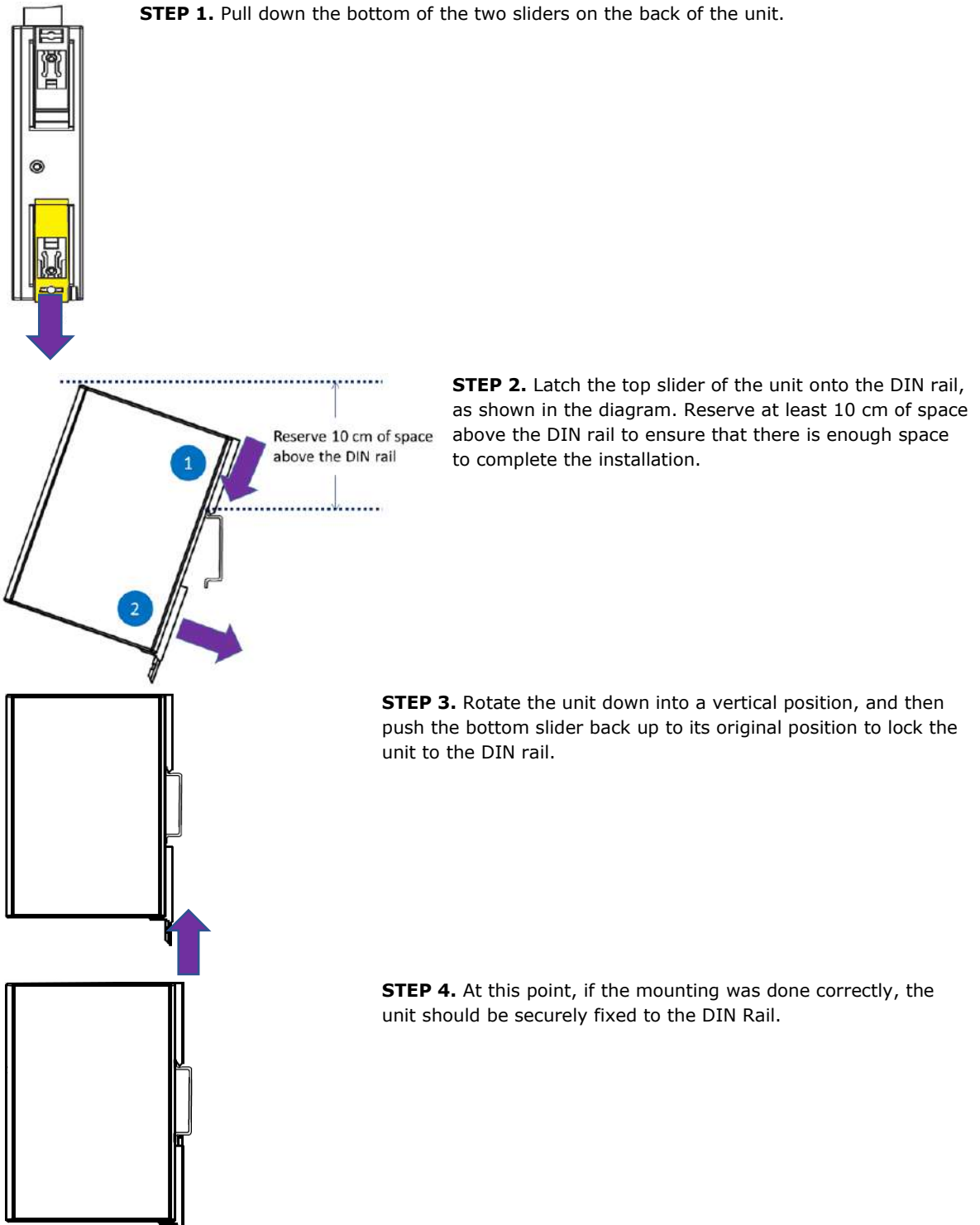

Wall Mounting



STEP 1. There are two sliders on the back of the unit, pull out both sliders out away from the product.

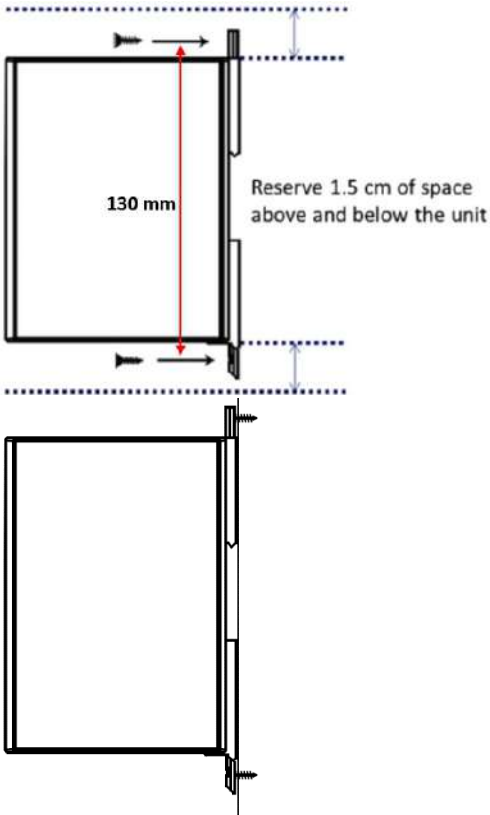

STEP 2. Use screws to fix the unit to the wall, as shown in the diagram. Reserve at least 1.5 cm of space above and below the unit to ensure that the installation can be done correctly. The distance between two wall mount holes is 130 mm.

STEP 3. At this point, if the mounting was done correctly, the unit should be securely fixed to the wall.

Grounding the Unit

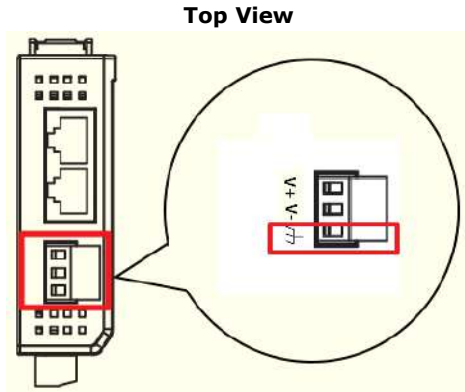

The ioLogik E1200 has a grounding point on the top panel of the terminal block. Connect the ground pin to earth ground.

Item	Suggested Setting
Wire range	12 to 24 AWG
Screw Torque	7 lb-inch

I/O Channel Jumper Setting

The following table shows jumper settings for each model of the ioLogik E1200 Series. We provide a more detailed description of three different jumper settings.

Model	Jumper Setting
E1212	DIO direction (DI, DO)
E1213	DIO direction (DI, DO) EXT Power Configuration
E1240	AI mode (Voltage, Current)
E1242	DIO direction (DI, DO) AI mode (Voltage, Current)

Take the following to open the unit.

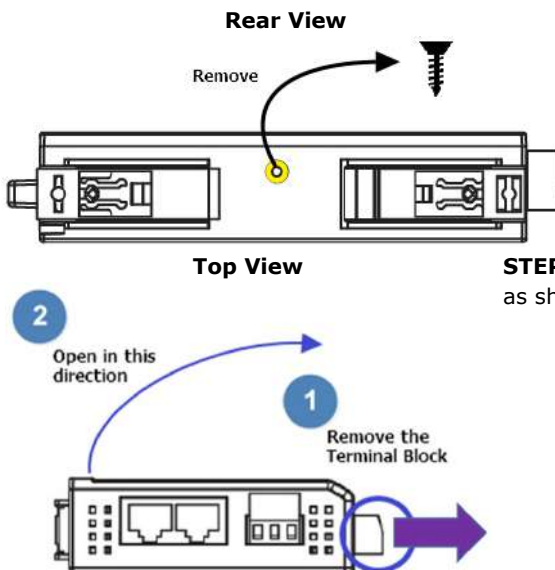

STEP 1. Remove the screw from the back panel. (Suggested Torque: 3.9 ± 0.4 kg-cm)

STEP 2. Remove the terminal block and open the top cover, as shown in the diagram.

STEP 3. The jumpers are near the IO channels. Jumper settings for different modes of operation are described below. In the diagrams, a triangle is used to show the direction of the setting.

DIO Direction (DI, DO)

DIO mode configuration settings are shown below:

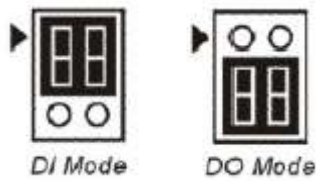

The default setting is DO Mode.

AI Mode (Voltage, Current)

Analog mode configuration settings are shown below:

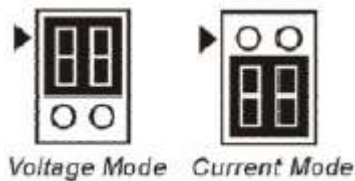

The default setting is voltage mode.

EXT Power Configuration

The ioLogik E1213 comes with a source type DO, which has three external (EXT) power configurations. Only one field power configuration can be selected at a time (JP10 / 12V JP5 / 9V JP11), and the jumper must be inserted vertically, not horizontally.

Example:

If the jumper is set to 12V, EXT power will be 12V.

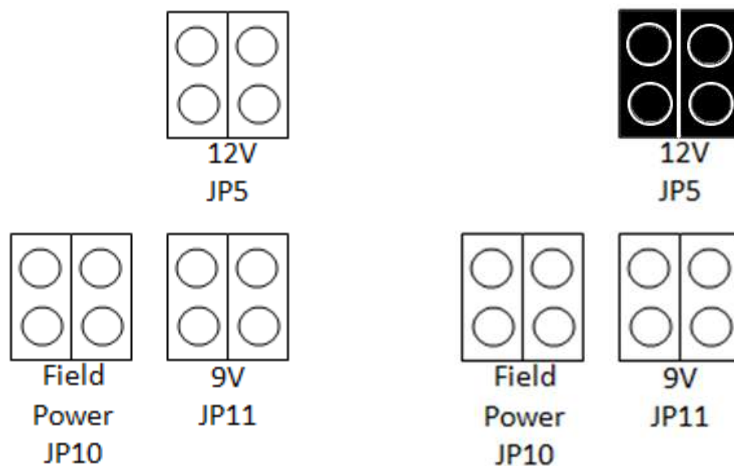

The default setting is Field Power JP10.



NOTE

The ioLogik E1213 has 4 pure DO channels and 4 hybrid DIO channels. For the 4 pure DO channels, you can use the jumpers to select the power configuration output (e.g., field power: 12 V, 9 V). But for the 4 hybrid DIO channels, you cannot use the jumpers to select the power configuration output. Instead, you can only use the jumpers to set the DIO channels to either DI mode or DO mode.

ioLogik E1212:

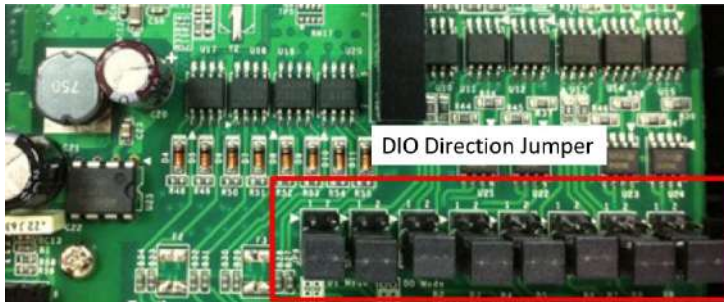

ioLogik E1213:

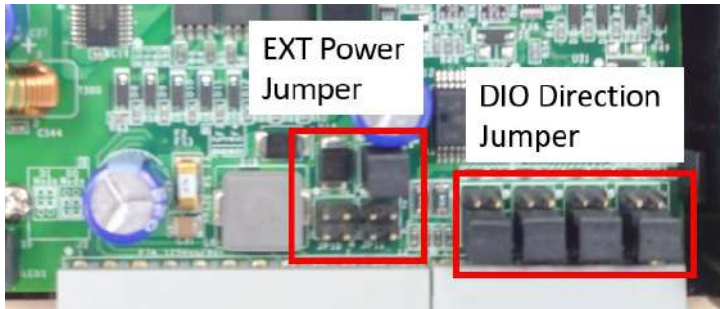

ioLogik E1240:



ioLogik E1242:

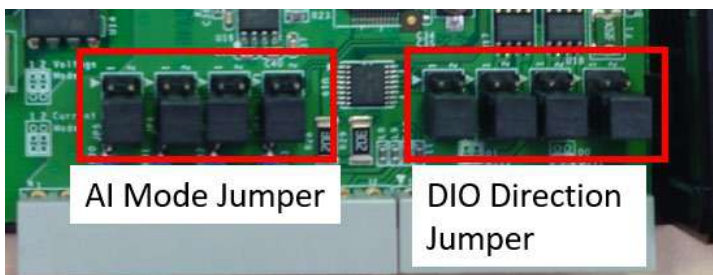

I/O Wiring

The following wiring guide explains how to configure seven different types of I/O channels:

Item	Suggested Setting
Wire range	16 to 26 AWG
Screw Torque	3 lb-inch

A **Dry Contact** is a contact that works without a power source. This applies to buttons, switches, etc.

A **Wet Contact** is a contact that must be connected to a power source to work. This applies to proximity sensors, motion sensors, etc.

Check the sensor type (NPN, PNP) and follow the corresponding wiring instructions.

DI Dry Contact

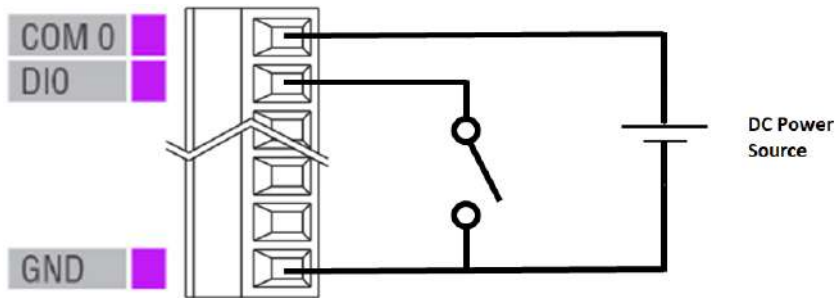

DI Wet Contact (NPN)

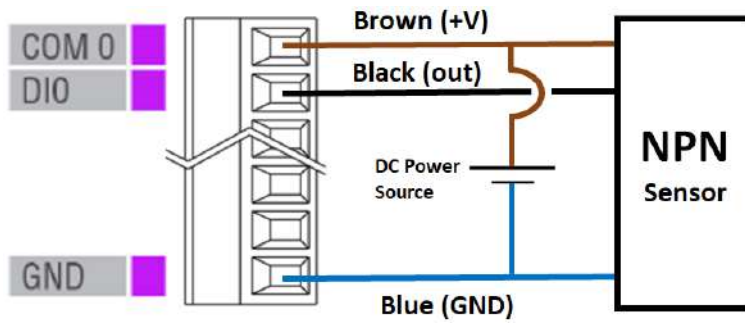

DI Wet Contact (PNP)

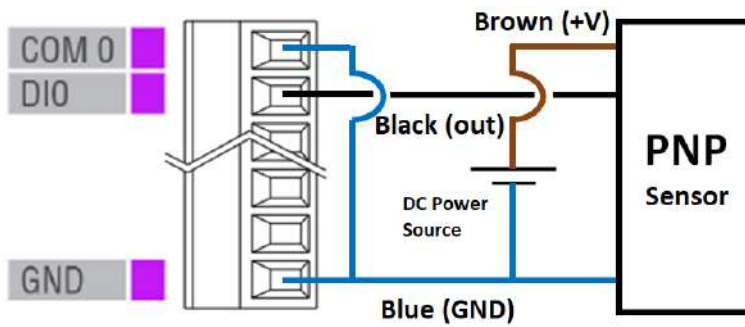

DO (Sink Type)

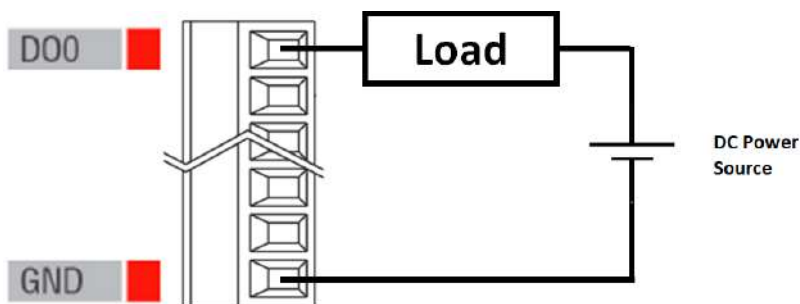

DO (Source Type)

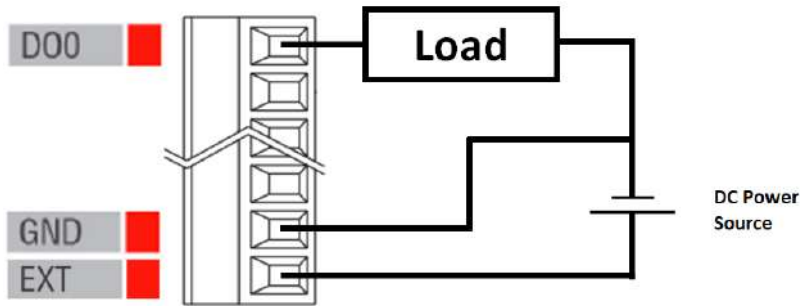

ATTENTION

DI and DIO Channels

Sensor types are grouped. If an NPN sensor is connected to DI-0, then only NPN sensors can be connected to the other DI channels in the group. Likewise, if a PNP sensor is connected to DI-9, then only PNP sensors can be connected to the other DI channels in the group.

For the group definition, please see the following table:

	Group 1	Group 2
E1210	DI-0 ~ DI-7	DI-8 ~ DI-15
E1212	DI-0 ~ DI-7	DIO-0 ~ DIO-7
E1213	DI-0 ~ DI-7	N/A
E1214	DI-0 ~ DI-5	N/A

Relay

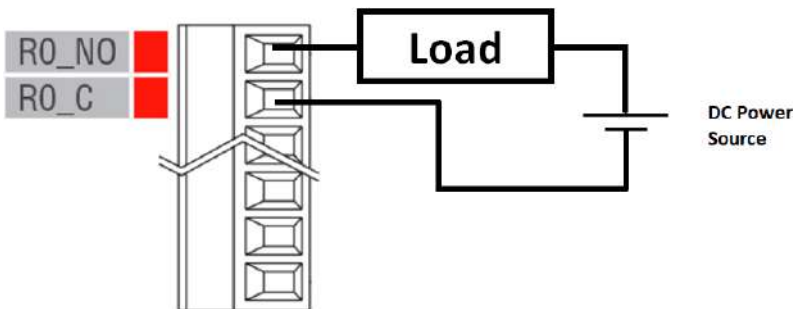

AI

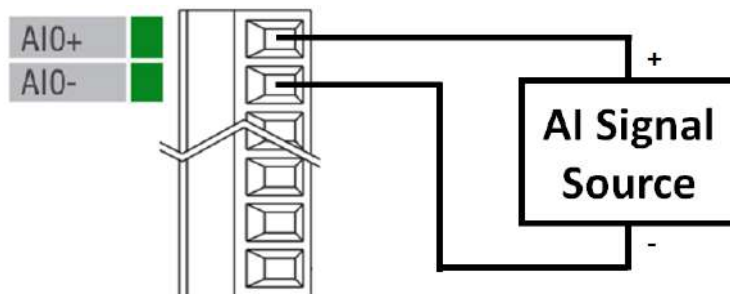

AO

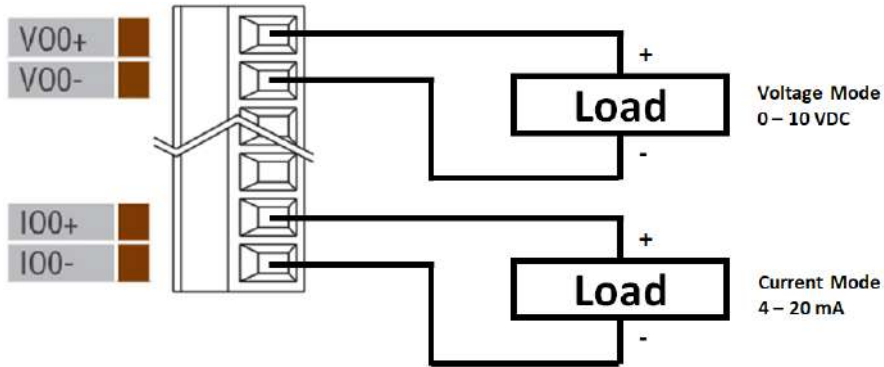

ATTENTION

Use the AO channel corresponding to the mode of operation you are using, as described above (e.g., voltage mode → VO, current mode → IO).

AO with external power

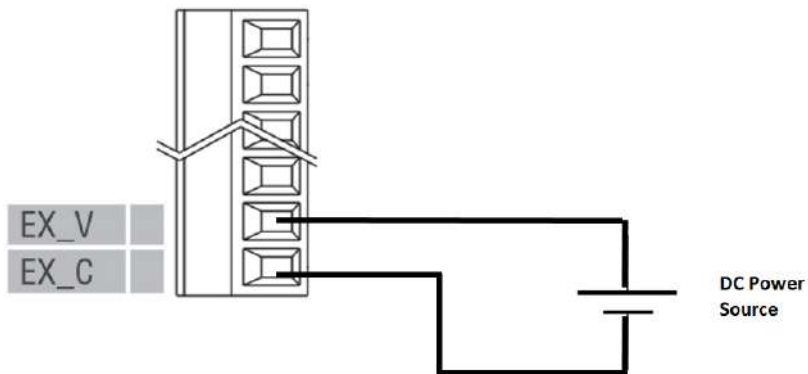

ATTENTION

24 V of external power required in Analog output when loading exceeds 1000 ohms.

2-Wire RTD

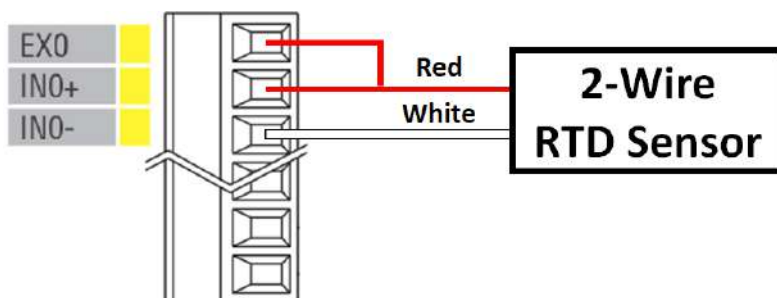

3-Wire RTD

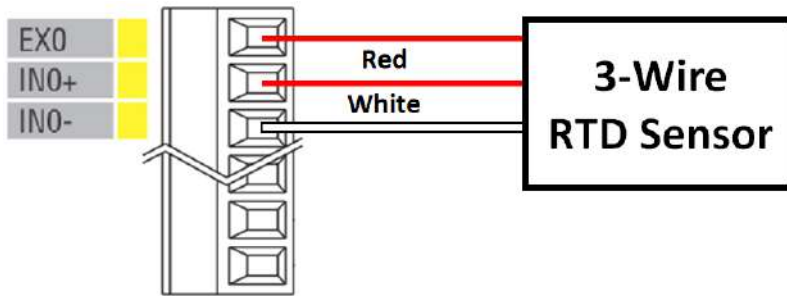

4-Wire RTD

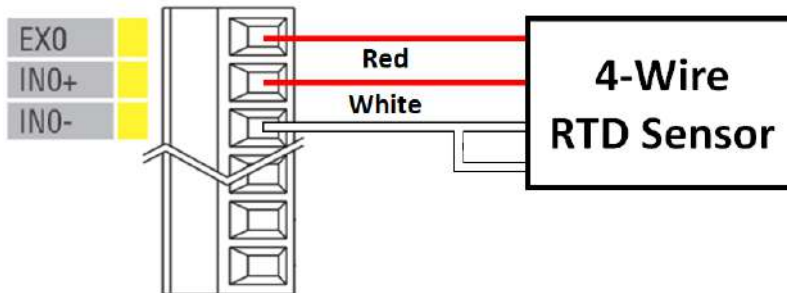

TC

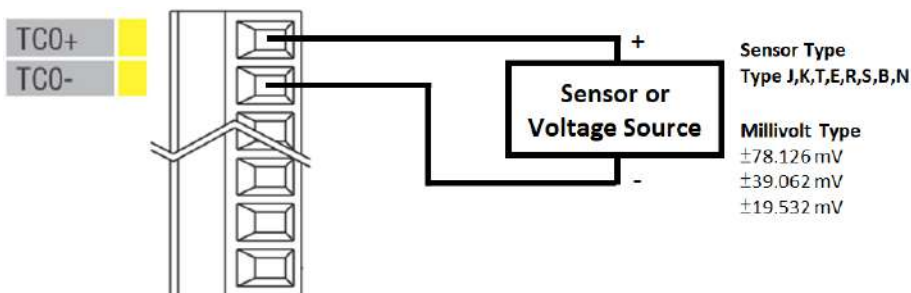

Communication Port Wiring

The product series offers the communication ports described below:

RJ45: Ethernet

The Ethernet ports (Port1/Port2) on the unit are unmanaged switch ports. Each of the two ports function essentially the same way.

Take the following steps to wire the communication port correctly.

Step 1: Measure the distance between the unit and your workstation/switch/connected equipment.



Step 2: Prepare an Ethernet cable (RJ45 connector) longer than the distance measured in Step 1.



Cable length \geq Measured distance in Step 1.

Step 3: Connect the RJ45 connector of the cable to Port1/Port2.

Top View

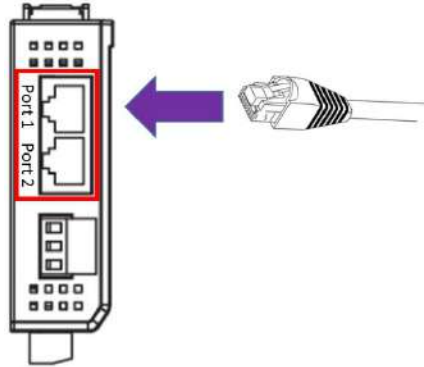

Use the Cable Tie Base to Securely Route a Connected I/O Cable

The products in this series have a cable tie base at the bottom of the unit for securely routing connected I/O cables, thereby decreasing the risk that the cable or terminal will be damaged accidentally.

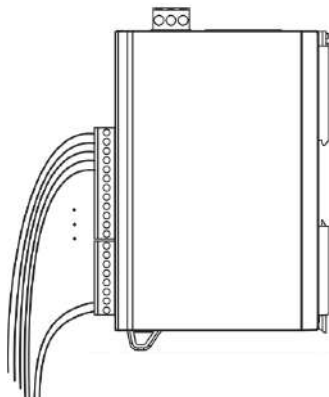

STEP 1. Refer to the I/O wiring section to wire the I/O channel.

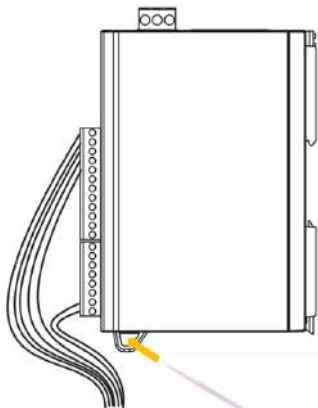

STEP 2. Insert the cable tie strap through the cable tie base.

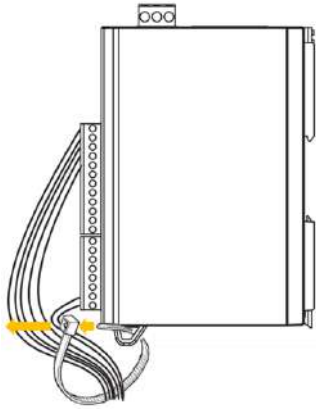

STEP 3. Fix the I/O channel cables to the cable tie base

Powering Up the Unit



WARNING

Confirm that the rated voltage of the connected DC Power Source is within 12 to 36 VDC to supply efficient power to the unit; if the power source does not supply voltage in this range, your unit could be damaged or operate unpredictably.



ATTENTION

Determine the maximum current for each power wire and common wire according to its size and maximum allowable current spec. If the current exceeds the maximum rating, the wiring may overheat, causing serious damage to your equipment. For safety reasons, we recommend an average cable size of 22 AWG. However, depending on the current load, you may want to adjust your cable size (the maximum wire size for power connectors is 2 mm).

The power terminal block is located on the top panel of the unit. Connect the unit to a 12 to 36 VDC power source as shown below.

Item	Suggested Setting
Wire range	12 to 24 AWG
Screw Torque	7 lb-inch

Top View

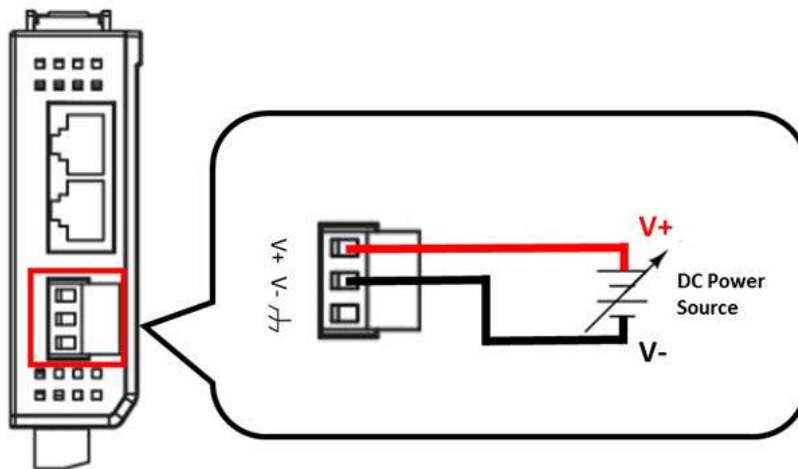

If power is properly supplied, the Power LED will glow a solid amber color. Continue to configure the software after you have finished installing the hardware.

ioSearch™ Installation

ioSearch™ is a search utility that helps the user locate ioLogik E1200 devices on the local network. You may download the latest version of ioSearch™ from Moxa's website.

1. **Installing the ioSearch™:** Download the ioSearch™ utility from Moxa's website, double click the installation file, and then follow the installation wizard's instructions to complete the installation.
2. **Open ioSearch:** After installation is finished, run ioSearch™ from **Start (Program Files (MOXA (IO Server (Utility (ioSearch.**
3. **Search the network for the server:** On the menu bar, select **System (Auto Scan Active Ethernet I/O Server.** A dialog window will pop up. Click **Start Search** to begin searching for the ioLogik E1200.

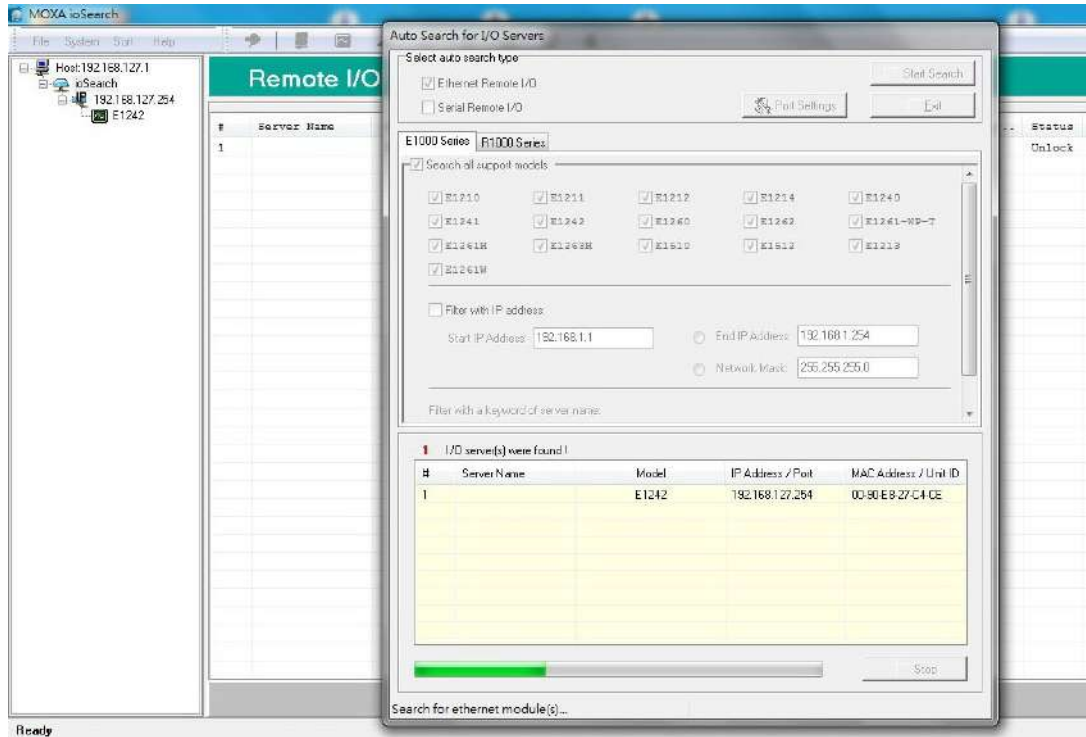

If multiple ioLogik E1200 units are installed on the same network, remember that each unit has the same default IP address. You will need to assign a different IP address to each unit to avoid IP conflicts.

Load Factory Default Settings

There are three ways to restore the ioLogik E1200 to factory default settings.

1. Hold down the RESET button for 5 seconds
2. Right-click on the specific ioLogik device in the ioSearch™ utility and select **Reset to Default**
3. Select **Load Factory Default** from the web console

3. Using the Web Console

The ioLogik E1200's main configuration and management utility is the built-in web console, which can configure a wide range of options.

Introduction to the Web Console

The ioLogik E1200 web console is a browser-based configuration utility. When the ioLogik E1200 is connected to your network, you may enter the server's IP address in your web browser to access the web console.



NOTE

The default password is "moxa".

The screenshot shows the web console interface for an ioLogik Remote Ethernet I/O Server. The top header includes the MOXA logo, the product name "ioLogik Remote Ethernet I/O Server", and the website "www.moxa.com". Below the header is a status bar with system information:

Model	- E1242 Ethernet I/O Server	IP	- 192.168.127.254	MAC Address	- 00-90-e8-4f-0a-36
Name	-	Serial No.	- TAEHC1023380	Firmware	- V2.5 Build16081019
Location	-	System Elapsed Time	- 00:08:02		

The main window is titled "Welcome to ioLogik Series" and "Remote Ethernet I/O Server". It displays the following system information:

Model Name	E1242
Serial Number	TAEHC1023380
Firmware Version	V2.5 Build16081019
BIOS Version	V2.2.0
Ethernet MAC Address	00-90-e8-4f-0a-36
Ethernet IP Address	192.168.127.254
Peer to Peer	Disable

The I/O Status section contains three tables:

DI Channel	Mode	Status	Filter	Counter Trigger
DI-00	DI	OFF	100.0 ms	--
DI-01	DI	OFF	100.0 ms	--
DI-02	DI	OFF	100.0 ms	--
DI-03	DI	OFF	100.0 ms	--

DO Channel	Mode	Status	ON Width	OFF Width
DO-00	DO	OFF	--	--
DO-01	DO	OFF	--	--
DO-02	DO	OFF	--	--
DO-03	DO	OFF	--	--

AI Channel	Range	Status	Value	Min	Max
AI-00	0-10V	Enable	0.005	0.000	0.006
AI-01	0-10V	Enable	0.005	0.000	0.033
AI-02	0-10V	Enable	0.004	0.000	0.005
AI-03	0-10V	Enable	0.006	0.000	0.007

The left navigation panel is titled "Main Menu - E1242" and lists various settings categories such as Overview, Network Settings, User-defined Modbus Addressing, AOPC Server Settings, I/O Settings, Peer to Peer Settings, SNMP Settings, RESTful Settings, EthernetIP Settings, System Management, Change Password, Load Factory Default, and Save/Restart.

The left panel is the navigation panel and contains an expandable menu tree for navigating among the various settings and categories. When you click on a menu item in the navigation panel, the main window will display the corresponding options for that item. Configuration changes can then be made in the main window. For example, if you click on **Network Settings** in the navigation panel, the main window will show a page of basic settings that you can configure.

You must click on the **Submit** button after making configuration changes. The **Submit** button will be located at the bottom of every page that has configurable settings. If you navigate to another page without clicking the **Submit** button, your changes will not be retained.

Submitted changes will not take effect until they are saved and the ioLogik E1200 is restarted!

You may save and restart the server in one step by clicking on the **Save/Restart** button after you submit a change. If you need to make several changes before restarting, you may save your changes without restarting by selecting **Save/Restart** in the navigation panel. If you restart the ioLogik E1200 without saving your configuration, the ioLogik E1200 will discard all submitted changes.



NOTE

The web console is best viewed with Internet Explorer 9 or higher; some functionality may not be supported when using other browsers.

Overview

The **Overview** page contains basic information about the ioLogik E1200, including the model name, serial number, firmware version, MAC address, and current IP address. Most importantly, you can see the current I/O status by pressing the F5 key on the computer keyboard to refresh the page.

ioLogik Remote Ethernet I/O Server
www.moxa.com

■ Model	- E1242 Ethernet I/O Server	■ IP	- 192.168.127.254	■ MAC Address	- 00-90-e8-4f-0a-36
■ Name	-	■ Serial No.	- TAEHC1023380	■ Firmware	- V2.5 Build16081019
■ Location	-	■ System Elapsed Time	- 00:08:02		

Welcome to ioLogik Series

Remote Ethernet I/O Server

Model Name	E1242
Serial Number	TAEHC1023380
Firmware Version	V2.5 Build16081019
BIOS Version	V2.2.0
Ethernet MAC Address	00-90-e8-4f-0a-36
Ethernet IP Address	192.168.127.254
Peer to Peer	Disable

I/O Status

DI Channel	Mode	Status	Filter	Counter Trigger
DI-00	DI	OFF	100.0 ms	--
DI-01	DI	OFF	100.0 ms	--
DI-02	DI	OFF	100.0 ms	--
DI-03	DI	OFF	100.0 ms	--

DO Channel	Mode	Status	ON Width	OFF Width
DO-00	DO	OFF	--	--
DO-01	DO	OFF	--	--
DO-02	DO	OFF	--	--
DO-03	DO	OFF	--	--

AI Channel	Range	Status	Value	Min	Max
AI-00	0-10V	Enable	0.005	0.000	0.006
AI-01	0-10V	Enable	0.005	0.000	0.033
AI-02	0-10V	Enable	0.004	0.000	0.005
AI-03	0-10V	Enable	0.006	0.000	0.007

- Main Menu - E1242

- Overview
- Network Settings
- User-defined Modbus Addressing
- AOPC Server Settings
- I/O Settings
- Peer to Peer Settings
- SNMP Settings
- RESTful Settings
- EthernetIP Settings
- System Management
- Change Password
- Load Factory Default
- Save/Restart

Network Settings for the Web Console

General Settings

On the **General Settings** page, you can assign a server name and location to assist you in differentiating between different ioLogik E1200 units. You may also configure the Modbus/TCP timeout interval or enable the **Communication Watchdog** function.

The screenshot shows the 'General Settings' page. Under the 'I/O Server Settings' section, there are several fields and options: 'Server Name' and 'Server Location' are text input fields. Below them is a checked checkbox for 'Enable Server Socket Idle Connection Timeout Interval' with a value of '60' and a help text 'sec (1-65535, default = 60, disable = 0)'. Next is an unchecked checkbox for 'Enable communication watchdog' with a value of '0' and a help text 'sec (1-65535, default = 0, disable = 0)'. Under the watchdog checkbox, there are radio buttons for 'Modbus/TCP' (selected) and 'Ethernet/IP'. Below that is an unchecked checkbox for 'Auto clear alarm for Safe Mode'. At the bottom left is a 'Locate I/O Server' button, and at the bottom right is an 'Enable I/O Locate' button.

Enable Server Socket Idle Connection Timeout Interval automatically disconnects the Modbus/TCP connection from the server after a specified time period to free up the port for the next connection.

Enable Communication Watchdog activates **Safe Mode** when a specified period of time has passed and there is a loss of Modbus/TCP or Ethernet/IP network connectivity. **Safe Mode** is specially designed for products with output channels to output a suitable value (see Chapter 3: [AO Safe Mode Settings](#)) or status (see Chapter 3: [DO Safe Mode Settings](#)) when the ioLogik E1200 cannot be controlled by a remote PC (such as in the event of a network failure). By default, the watchdog is disabled. Users can configure how each output channel responds on the I/O Settings page.

To enable the Communication Watchdog function, select the **Enable Communication Watchdog** checkbox (you can only choose either Modbus/TCP or Ethernet/IP), set the timeout value, and then restart the server. When the watchdog is enabled, the ioLogik E1200 will enter **Safe Mode** after there is a disruption in communication that exceeds the specified time limit.

Auto clear alarm for Safe Mode automatically clears **Safe Mode** when the Modbus/TCP or Ethernet/IP network connectivity returns to normal. This function is only available in models with analog or digital output channels.

Enable I/O Locate enables remote toggling of the **Ready** LED from off to flashing to enable remote control of LEDs for easier location of devices when troubleshooting.

Ethernet Configuration

On the **Ethernet Configuration** page, you can set up a static or dynamic IP address for the ioLogik E1200 and configure the subnet mask and gateway address.

The screenshot shows the 'Ethernet Configuration' page. Under the 'Ethernet Parameters' section, there are four rows of configuration options: 'IP Configuration' is a dropdown menu set to 'Static'; 'IP Address' is a text input field with '192.168.127.254'; 'Subnet Mask' is a text input field with '255.255.255.0'; and 'Gateway' is a text input field with '0.0.0.0'. At the bottom left is a 'Submit' button.

User-defined Modbus Addressing

The input and output addresses can be configured on this page. Select the **Enable Modbus/TCP Slave Protocol** checkbox, and then configure the start address of each Modbus function. If you do not want to use the Modbus function, deselect the **Enable Modbus/TCP Slave Protocol** checkbox.

User-defined Modbus Addressing

Enable Modbus/TCP Slave Protocol

User-Defined Modbus address							
No.	Description	User-defined Start Address (DEC)	Function Code	Read/Write	Reference Address (DEC)	Total Channels	Data Type
1	DO Value	0000	01:COIL STATUS	RW	00001	4	1 bit
2	DO Pulse Status	0016	01:COIL STATUS	RW	00017	4	1 bit
3	DO Value All Channel (Ch0-Ch3)	0032	03:HOLDING REGISTER	RW	40033	1	1 WORD
4	DI Value	0000	02:INPUT STATUS	R	10001	8	1 bit



NOTE

The maximum number of Modbus TCP master connections is 10.

Default Modbus Address

You can view the default Modbus address for all I/O devices on the **Default Modbus Address** settings page. However, only the starting address will be displayed for each item with multiple reference addresses. For example, if the reference addresses for DI Value start from 10001 and the second DI channel's reference address is 10002, only the first DI channel's Modbus address of 10001 will be displayed. See the diagram below.

Default Modbus Address

Default Modbus address							
No.	Description	User-defined Start Address (DEC)	Function Code	Read/Write	Reference Address (DEC)	Total Channels	Data Type
1	DI Value	0001	02:INPUT STATUS	R	10001	16	1 BIT
2	DI Counter Value Double Word	0017	04:INPUT REGISTER	R	30017	16	2 WORD
3	DI Value All Channel (Ch0-Ch15)	0049	04:INPUT REGISTER	R	30049	1	1 WORD
4	DI Counter Start/Stop	0257	01:COIL STATUS	RW	00257	16	1 BIT
5	DI Counter Clear	0273	01:COIL STATUS	RW	00273	16	1 BIT



ATTENTION

Disable the user-defined Modbus addressing function if using the MXIO (.NET) library or MX-AOPC UA Server to control or monitor the ioLogik E1200's I/O status.

AOPC Server Settings

Moxa's MX-AOPC Server™ is a software package operated as an OPC driver of an HMI or SCADA system. It seamlessly connects Moxa's ioLogik products to a wide variety of SCADA systems, including the most popular: Wonderware, Citect, and iFix. MX-AOPC UA Server™ conforms to the OPC UA standard to connect with other standard-compliant devices and host OPC machines.

Hardware Requirements	
CPU	Intel Pentium 4 or above
RAM	512 MB (1024 MB recommended)
Communication Interface	Ethernet or serial

Software Requirements	
Operating System	Microsoft Windows 7/8/10, Microsoft Windows Server 2003/2008/2012
Editor (optional)	Microsoft Office 2003 (Access or Excel) or later
Database (optional)	Oracle database, Microsoft SQL Server

OPC UA Server Specifications	
OPC Unified Architecture	1.01
OPC Data Access	1.0a, 2.0, 2.05a, 3.0
Device Protocols	Moxa AOPC, Modbus/TCP (master), Modbus/RTU (master)

OPC UA Logger Specifications	
OPC Unified Architecture	1.01

MX-AOPC UA Server can be downloaded from the Moxa website at <https://www.moxa.com>

After downloading the MX-AOPC UA Server file, unzip the file and run Install.exe. The installation program will guide you through the installation process and install the MX-AOPC UA Server Utility.

For more details on MX-AOPC UA Server installation and use, please check the user's manual, which can be downloaded from Moxa's website.

Tag Generation

The ioLogik E1200 Series implements Moxa's Active Tag technology to proactively communicate with the MX-AOPC UA Server and MXIO library, a library that speeds up application development with the ioLogik Series. The Active Tag, also called AOPC Tag, needs to be generated before using.

Use the web console to create AOPC tags for the ioLogik E1200 by opening your browser and navigating to the **AOPC Server Settings** page.

Follow these steps to create the tags and send them from the ioLogik E1200 to MX-AOPC UA Server:

1. On the **AOPC & I/O Settings** page, select the **Enable Active OPC** checkbox and specify the IP address where the MX-AOPC UA Server is installed.
2. Select the I/O channels that need to be created in MX-AOPC UA Server.
3. Configure the **Heartbeat Interval**, if necessary.



NOTE

The **Heartbeat Interval** can determine the connection status between the ioLogik E1200 and MX-AOPC UA Server, and to ensure that the ioLogik is connected and alive. If the heartbeat interval is set and the network between the ioLogik E1200 and MX-AOPC UA Server is down, MX-AOPC UA Server will detect the stopped heartbeat and the **Quality** column in the MX-AOPC UA will display BAD to indicate the loss of connectivity.

- Main Menu - E1242
- Overview
- Network Settings
- User-defined Modbus Addressing
- Analog Inputs, Digital Inputs/Outputs
 - Default Address
- AOPC Server Settings
 - AOPC & I/O Settings
 - Create AOPC Tag
- I/O Settings
- Peer to Peer Settings
- SNMP Settings
- RESTful Settings
- EthernetIP Settings
- System Management
 - Change Password
 - Load Factory Default
 - Save/Restart

Active OPC Server Settings

Enable Active OPC

No.	IP Address	Port
1	<input type="text"/>	9900
2	<input type="text"/>	9900

I/O Channel Settings

Update by I/O On Change, Interval sec

Enable all DI Channels

Ch00 Ch01 Ch02 Ch03 Ch04 Ch05 Ch06 Ch07

Enable all DO Channels

Ch00 Ch01 Ch02 Ch03

Enable All AI Channels

Ch00	<input type="checkbox"/> On Change:	<input type="text" value="1.00"/> %	<input type="checkbox"/> Update per:	<input type="text" value="1"/> sec	<input type="text" value="1-65535"/>
Ch01	<input type="checkbox"/> On Change:	<input type="text" value="1.00"/> %	<input type="checkbox"/> Update per:	<input type="text" value="1"/> sec	<input type="text" value="1-65535"/>
Ch02	<input type="checkbox"/> On Change:	<input type="text" value="1.00"/> %	<input type="checkbox"/> Update per:	<input type="text" value="1"/> sec	<input type="text" value="1-65535"/>
Ch03	<input type="checkbox"/> On Change:	<input type="text" value="1.00"/> %	<input type="checkbox"/> Update per:	<input type="text" value="1"/> sec	<input type="text" value="1-65535"/>

Active OPC Server Heartbeat Settings

Heartbeat Interval: sec (0 for disable, or range)

Configuration Complete!

Warning! The changes will take effect until you Save/Restart the I/O Server.

You can Save / Restart the I/O Server now or Save / Restart the I/O Server when all settings complete.

- Main Menu - E1240
- Overview
- Network Settings
- User-defined Modbus Addressing
- Active OPC Server Settings
 - AOPC & I/O Settings
 - Create AOPC Tag
- I/O Settings
- System Management
 - Change Password
 - Load Factory Default
 - Save/Restart

Create Active OPC Tag

I/O Settings

DI Channels

The status of each DI (digital input) channel appears on the **DI Channel Settings** page.

DI Channel Settings

Refresh page

DI Channel	Mode	Status	Filter	Counter Trigger
DI-00	DI	OFF	100.0 ms	--
DI-01	DI	OFF	100.0 ms	--
DI-02	DI	OFF	100.0 ms	--
DI-03	DI	OFF	100.0 ms	--
DI-04	DI	OFF	100.0 ms	--
DI-05	DI	OFF	100.0 ms	--
DI-06	DI	OFF	100.0 ms	--
DI-07	DI	OFF	100.0 ms	--
DI-08	DI	OFF	100.0 ms	--
DI-09	DI	OFF	100.0 ms	--
DI-10	DI	OFF	100.0 ms	--
DI-11	DI	OFF	100.0 ms	--

You can also configure each channel's digital input mode and parameters by clicking on the channel. DI channels can operate in **DI mode** or **Event Counter mode**.

DI Channel 0 Settings

Mode	Filter	Counter Trigger	Counter Start/Enable
[1. Current Setting]			
DI	100		
[2. Power On Setting]			
Counter			
[3. Save Counter On Power Failure]			

Filter unit = 1 ms, range = 1–65535

Activate **Event Counter** mode by selecting the **Counter Start** field and configure the **Counter Trigger** by selecting **Lo to Hi**, **Hi to Lo**, or **Both** from the drop-down menu. When the **Counter Start** field is not selected, you can still activate the counter by using Modbus commands.



NOTE

Confirm that the Counter Filter is not set to 0; otherwise, the counter will never be activated.

DI Channel 0 Settings

Mode	Filter	Counter Trigger	Counter Start/Enable
[1. Current Setting]			
Counter	100	Lo to Hi	<input type="checkbox"/>
[2. Power On Setting]			
		Lo to Hi Hi to Lo Both	<input type="checkbox"/>

Power On Setting: You may configure DI channels in **Event Counter** mode whether counting begins when powering up.

Save Counter on Power Failure: The ioLogik E1200 will automatically save the counter value when there is a power failure if this function selected.

Initial Counter Value Setting: The initial counter value when powering up.



NOTE

This setting will be overwritten if the above Save Counter On Power Failure is checked.

Reset Counter: Select this function to reset the counter.

[2. Power On Setting]	<input type="checkbox"/>
[3. Save Counter On Power Failure]	<input type="checkbox"/>
[4. Initial Counter Value Setting]	<input type="checkbox"/>
Value <input type="text" value="0"/>	<input type="checkbox"/>
[5. Reset Counter]	<input type="checkbox"/>

Counter Overflow: If the value of the counter is over the maximum counter value of 4294967295, the word Overflow will be displayed in the web console; the actual counter value will restart counting from 0. To display the current counter value in the web console, check the **Clear Overflow** checkbox, as shown below.

DI Channel 0 Settings

Mode	Filter	Counter Trigger	Counter Start/Enable
[1. Current Setting]			
Counter ▾	<input type="text" value="100"/>	Lo to Hi ▾	<input checked="" type="checkbox"/>
[2. Power On Setting]			
			<input checked="" type="checkbox"/>
[3. Save Counter On Power Failure]			
			<input type="checkbox"/>
[4. Initial Counter Value Setting]			
Value <input type="text" value="4294967295"/>			<input checked="" type="checkbox"/>
[5. Reset Counter]			
			<input type="checkbox"/>
[6. Clear Overflow]			
			<input checked="" type="checkbox"/>

Counter Scaling: Select the **Enable Counter Scaling** checkbox to enable the counter scaling function. To use this function, define the gain and offset values, and define the update interval.

For example, if the gain is 5, and the offset is 10, the counter result will be (count difference x 5) + 10.

[7. Counter Scaling]	
[Slope-Intercept Formula]	
<input type="checkbox"/> Enable Counter Scaling	
Result=Count Difference * <input type="text" value="1"/>	+ <input type="text" value="0"/>
Update every <input type="text" value="5"/>	sec

The DI channel's **Alias Name** and logic definition can also be configured on this page. You can apply the alias name to all channels by selecting the **Apply to all DI channels** checkbox.

Apply to all DI channels

Alias name of channel

DI

Alias name of "OFF" status

OFF

Alias name of "ON" status

ON

Submit Close

DI Channel Specification:

Apply to all DI channels

[9. Alias Name]

Alias name of channel

DI-00

Alias name of "OFF" status

OFF

Alias name of "ON" status

ON

Submit Close

Note1: Filter unit=1ms, range=1~65535.

Note2:

Sensor Type -> Wet Contact (Source or Sink) and Dry Contact.

Dry Contact -> OFF : Open.

-> ON : Short to GND.

Wet Contact (Sink/NPN) -> OFF : 10 - 30VDC.

-> ON : 0 - 3 VDC.

Wet Contact (Source/PNP) -> OFF : 0 - 3 VDC.

-> ON : 10 - 30VDC.

WARNING: Be sure to Save/Restart your settings.

DO Channels

On the **I/O Setting: DO (Digital Output) Channels** page; you can configure each DO channel by clicking on the channel.

DO Channel	Mode	Status	ON Width	OFF Width
DO-00	Pulse Output	STOP	100.0 ms	100.0 ms
DO-01	Pulse Output	STOP	100.0 ms	100.0 ms
DO-02	Pulse Output	STOP	100.0 ms	100.0 ms
DO-03	Pulse Output	STOP	100.0 ms	100.0 ms
DO-04	Pulse Output	STOP	100.0 ms	100.0 ms
DO-05	Pulse Output	STOP	100.0 ms	100.0 ms
DO-06	Pulse Output	STOP	100.0 ms	100.0 ms
DO-07	Pulse Output	STOP	100.0 ms	100.0 ms
DO-08	Pulse Output	STOP	100.0 ms	100.0 ms
DO-09	Pulse Output	STOP	100.0 ms	100.0 ms
DO-10	Pulse Output	STOP	100.0 ms	100.0 ms
DO-11	Pulse Output	STOP	100.0 ms	100.0 ms
DO-12	Pulse Output	STOP	100.0 ms	100.0 ms
DO-13	Pulse Output	STOP	100.0 ms	100.0 ms
DO-14	Pulse Output	STOP	100.0 ms	100.0 ms
DO-15	Pulse Output	STOP	100.0 ms	100.0 ms

DO channels can operate in **DO** mode when the status is either ON or OFF.

DO Channel 0 Settings

Mode	DO Status	ON Width*	OFF Width*	Pulse Count	Pulse Start
[1. Current Setting]:					
DO	OFF				
[2. Power On Setting]:					
	OFF				
	ON				
	OFF				

If you select **Pulse Output** mode, you can specify the **ON Width** and **OFF Width** to generate a square wave.

DO Channel 0 Settings

Mode	DO Status	ON Width*	OFF Width*	Pulse Count	Pulse Start
[1. Current Setting]:					
Pulse Output		1	1	0	<input type="checkbox"/>

Pulse Width unit = 1 ms, range = 1–65535

When configuring individual channels, if the **Power On Setting** is selected, the Pulse Output will start as soon as the ioLogik E1200 is powered on. If the **Safe Status Setting** is selected, the Pulse Output will start only when the E1200 has entered Safe Status mode. In contrast, when neither of these settings is selected and the **Pulse Start** field is selected, the ioLogik E1200 will automatically stop the Pulse Output when the ioLogik E1200 is either powered on or in Safe Status mode.



NOTE

Safe Status is controlled by the Communication Watchdog under General Settings, which is disabled by default. If the Communication Watchdog is disabled, the ioLogik E1200 will never enter Safe Mode and your Safe Status settings will have no effect.

DO Channel 0 Settings

Mode	DO Status	ON Width*	OFF Width*	Pulse Count	Pulse Start
[1. Current Setting]:					
DO	OFF				
[2. Safe Status Setting]:					
Pulse Output	OFF				
[3. Safe Status Setting]:					
HOLD LAST					
<input type="checkbox"/> Apply to all DO channels					
[4. Alias Name]:					
Alias name of channel					
DO					
Alias name of "OFF" status					
OFF					
Alias name of "ON" status					
ON					
<input type="button" value="Submit"/> <input type="button" value="Close"/>					

The DO channel's **Alias Name** and logic definition can also be configured on this page. You can apply the alias name to all channels by clicking on the **Apply to all DO channels** box.

Apply to all DO channels

[4. Alias Name]:					
Alias name of channel					
DO					
Alias name of "OFF" status					
OFF					
Alias name of "ON" status					
ON					
<input type="button" value="Submit"/> <input type="button" value="Close"/>					

AI Channels

The current status of each AI (analog input) channel can be viewed on the **AI Channel Settings** page.

AI Channel Settings

AI Channel	Range	Value	Min.	Max.
AI-00	0-10V	0.010V	0.007V	0.010V
AI-01	0-10V	0.009V	0.009V	0.012V
AI-02	0-10V	0.009V	0.006V	0.009V
AI-03	0-10V	0.007V	0.007V	0.010V
AI-04	0-10V	0.010V	0.010V	0.013V
AI-05	0-10V	0.009V	0.009V	0.012V
AI-06	0-10V	0.008V	0.008V	0.011V
AI-07	0-10V	0.009V	0.009V	0.012V



NOTE

The sampling rate per channel depends on how many AI channels are enabled.
For example, for the ioLogik E1240:

- If 8 AI channels are enabled, then the sampling rate = 1.5 Hz for each enabled channel
- If 4 AI channels are enabled, then the sampling rate = 3 Hz for each enabled channel
- If 1 AI channels is enabled, then the sampling rate = 12 Hz for each enabled channel

Click on a specific AI channel to enable or disable it by selecting the **Enable AI Channel** field. There are two modes available for the AI channels:

1. **Voltage Mode** (See the [Jumper Settings \(DIO and AI\)](#) in Chapter 2 for more details)

Enable AI Channel

AI Input Range

0-10V

N/A (0.000 - 3.999 mA) only available on BO mode

* (input < BO (mA), RAW Data=0)

Notes: Only [0-10 V] and [4-20 mA] mode support Peer to Peer function

2. **Current Mode** (See the [Jumper Settings \(DIO and AI\)](#) in Chapter 2 for more details)

Enable AI Channel

AI Input Range

4-20mA

2.000 (0.000 - 3.999 mA) only available on BO mode

* (input < BO (mA), RAW Data=0)

Notes: Only [0-10 V] and [4-20 mA] mode support Peer to Peer function

Auto Scaling and **Slope-intercept** functions of the AI value can be defined on this page.

Auto Scaling Settings

Disable Scaling

Enable Point-Slope formula

	Actual (x.xxx)		Scaled (x.xxx)
Min (n1)	<input type="text"/>	Min (n2)	<input type="text"/>
Max (m1)	<input type="text"/>	Max (m2)	<input type="text"/>
Unit	<input type="text"/>	Unit	<input type="text"/>

*Result = $n2 + (input - n1) \times [(m2-n2)/(m1-n1)]$

Enable Slope-intercept

M=

D=

Unit

*Result = $M \times Input + D$

Apply to All Channels

AI Input Range

Set the AI input ranges for each mode, as follows:

1. **Voltage Mode (V)** (See **Jumper Settings (DIO and AI)** in Chapter 2 for more details)
There is only one default analog **Voltage** input range: [0-10V]
2. **Current Mode (mA)** (See **Jumper Settings (DIO and AI)** in Chapter 2 for more details)
There are three modes in the analog **Current** input range: [4-20 mA], [0-20 mA], [4-20 mA (Burn Out)]



NOTE

Only input ranges [0-10 V] and [4-20 mA] support peer-to-peer networking.

AI Input: Current Mode

Enable AI Channel

AI Input Range

4-20mA

4-20mA

4-20mA (Burn Out) (0.000 - 3.999 mA) only available on BO mode

0-20mA V Data=0

Notes: Only [0-10 V] and [4-20 mA] mode support Peer to Peer function

Burn Out mode indicates when the Current AI has burned out. For example, the 4–20 mA **Burn Out** mode is defined in the following diagram:

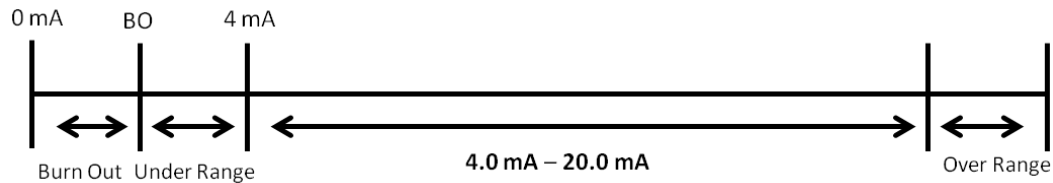

Users can define **Burn Out** (BO) values (default = 2 mA) for selected ranges. When input values are in the **Burn Out** range, raw data will register as 0000h to indicate that the analog input has burned out. The definition of raw data is as follows:

Burnout Value (BO)	0.0 < BO < 4.0	User defined (default 2 mA)
Burnout State	0 ≤ AI < BO mA	S/W output 0000h
Under Range	BO ≤ AI < 4 mA	S/W output raw data
Normal Range	4 ≤ AI ≤ 20.00 mA	S/W output raw data until FFFh
Over Range	XX > 20.00 mA	S/W output FFFFh

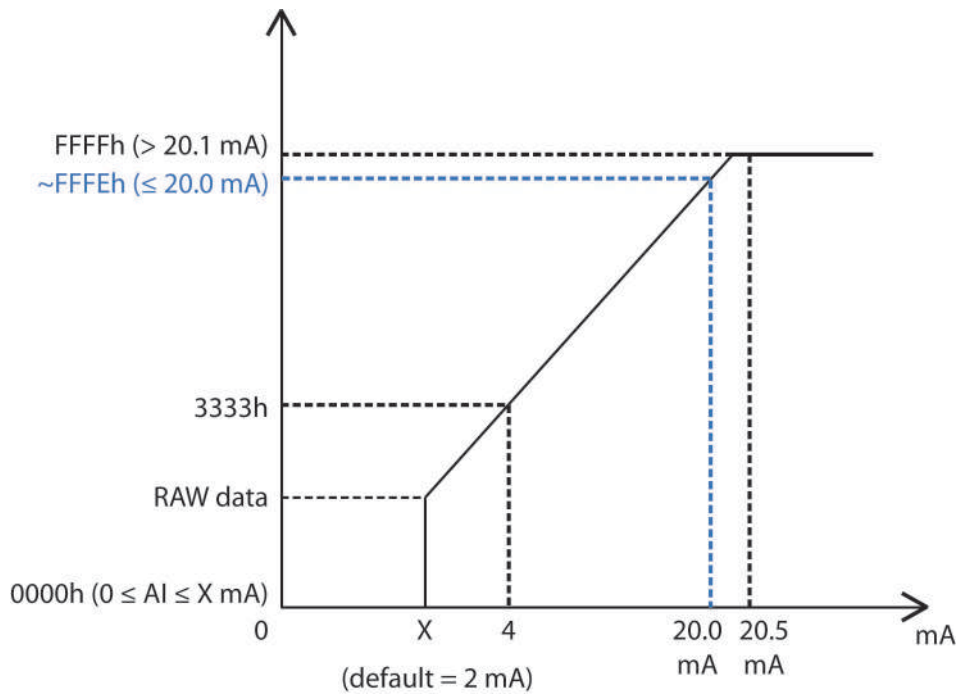

ATTENTION

When configuring the jumpers to select voltage or current measurement for the AI channels, open the cover by first removing the screw on the back panel. For details on jumper settings, see the [Jumper Settings \(DIO and AI\)](#) section in Chapter 2.

Selecting **Enable Point-Slope formula** on the **Auto Scaling Settings** page will linearly convert the actual current or voltage value into other user-defined units, such as percentage or ppm (parts per million).



NOTE

The scaled value's Modbus address differs from the original value.

Auto Scaling Settings

- Disable Scaling
- Enable Point-Slope formula

	Actual (x.xxx)		Scaled (x.xxx)
Min (n1)	<input type="text" value="0.000"/>	Min (n2)	<input type="text" value="0.000"/>
Max (m1)	<input type="text" value="10.000"/>	Max (m2)	<input type="text" value="1000.000"/>
Unit	<input type="text" value="V"/>	Unit	<input type="text" value="ppm"/>

*Result = $n2 + (input - n1) \times [(m2-n2)/(m1-n1)]$

The slope-intercept function is used to compensate when the measurement requires a slight adjustment.

- Enable Slope-intercept

M=	<input type="text" value="1.1"/>
D=	<input type="text" value="0.02"/>
Unit	<input type="text" value="V"/>

*Result = $M \times Input + D$

The AI channel's **Alias Name** can also be configured on this page.

Alias Name of Channel

AO Channels

The current status of each AO (analog output) channel can be viewed on the **AO Channel Settings** page:

AO Channel Settings

AO Channel	Range	Value
AO-00	4-20mA	4.000mA/4.000mA
AO-01	4-20mA	4.000mA/4.000mA
AO-02	0-10V	0.000V/0.000V
AO-03	0-10V	0.000V/0.000V

Click on a specific channel to access the AO channel settings, and then select the **Enable AO Channel** box. The Auto Scaling function of the AO value can be defined on the same page.

There are two modes for the AO channels, **Voltage Mode (V)** and **Current Mode (mA)**.

Enable AO Channel

Analog Output Range	Analog Output Value
Current Range	
<input type="radio"/> 0-10V	<input type="text" value="0"/> [0-4095]
<input checked="" type="radio"/> 0-10V	<input type="text" value="4"/> [0.00-10.00V]
<input type="radio"/> 4-20mA	
Power On Setting	
	<input type="text" value="0"/> [0-4095]
Safe Status Setting	
	<input type="text" value="0"/> [0-4095]

RAW Value Hold Last

Enabling the **Point-Slope Formula** function on the **Auto Scaling Settings** page will linearly convert the actual current or voltage value into other user-defined units, such as percentage or ppm (parts per million).



NOTE

The scaled value's Modbus address differs from the original value.

Auto Scaling Settings

- Disable Scaling
 Enable Point-Slope formula

	Actual (x.xxx)		Scaled (x.xxx)
Min (n1)	<input type="text"/>	Min (n2)	<input type="text"/>
Max (m1)	<input type="text"/>	Max (m2)	<input type="text"/>
Unit	<input type="text"/>	Unit	<input type="text"/>

*Result = $n2 + (input - n1) \times [(m2-n2)/(m1-n1)]$

- Apply to All Channels

The AO channel's **Alias Name** can also be configured on this page.

Alias Name Settings

Alias Name of Channel

RTD Channels

The current status of each RTD (Resistance Temperature Detector) channel can be viewed on the **RTD Channel** page.

RTD Channel Settings

RTD Channel	Sensor Type	Range	Status	Value	Min	Max
RTD-00	PT 100	-200 ~ 850°C	Enabled	--	--	--
RTD-01	PT 100	-200 ~ 850°C	Enabled	--	--	--
RTD-02	PT 100	-200 ~ 850°C	Enabled	--	--	--
RTD-03	PT 100	-200 ~ 850°C	Enabled	--	--	--
RTD-04	PT 100	-200 ~ 850°C	Enabled	--	--	--
RTD-05	PT 100	-200 ~ 850°C	Enabled	--	--	--

Click on a specific channel to access the RTD channel settings.

Select the **Enable RTD Channel** checkbox and then select the sensor type from the dropdown menu that meets the physical attachment to the ioLogik E1200.

RTD Channel 0 Settings

Enable RTD Channel

RTD Sensor Type	Range	Unit
PT 100 ($\alpha = 0.00385$)	-200 ~ 850	°C

Apply to All Channels

Alias Name Settings

Alias Name of Channel

WARNING: Be sure to Save/Restart your settings

The ioLogik E1200 allows you to calibrate the temperature sensors. In each channel configuration section, follow the instructions and click the **Calibrate** button to start the RTD sensor calibration. Each calibration requires around 30 seconds per channel.

Calibration

Select Channel :

Sensor Type:

1. Ensure the sensor is connected.
2. Ensure the channel and its sensor type is correctly selected.
3. Put the sensor into a glass that contains a mixture of ice and water.
4. Click on the "Calibrate" button.
5. Wait until the page shows "Calibration Completed".

NOTE:

1. Do not remove the sensor from the ice water during calibration.
2. Load factory default will clear the current calibrated settings.

NOTE: Resistance types of sensors are not supported to be calibrated.

The ioLogik E1200 allows you to manually adjust the current temperature reading. In each channel configuration section, select the channel, apply the offset value, and click the **Submit** button.

Offset

Channel	Offset	Unit
Select Channel : <input type="text" value="Channel 0"/>	<input type="text" value="1.8"/>	<input type="text" value="°C"/>

NOTE: Offset range: -1000.0 to +1000.0, unit = 0.1 °C/°F.

TC Channels

The current status of each TC (Thermocouple) channel can be viewed on the **TC Channel** page.

TC Channel Settings

TC Channel	Sensor Type	Range	Status	Value	Min	Max
TC-00	E TYPE	-200 ~ 900°C	Enabled	--	--	--
TC-01	K TYPE	-200 ~ 1250°C	Enabled	--	--	--
TC-02	K TYPE	-200 ~ 1250°C	Enabled	--	--	--
TC-03	K TYPE	-200 ~ 1250°C	Enabled	--	--	--
TC-04	K TYPE	-200 ~ 1250°C	Enabled	--	--	--
TC-05	K TYPE	-200 ~ 1250°C	Enabled	--	--	--
TC-06	K TYPE	-200 ~ 1250°C	Enabled	--	--	--
TC-07	K TYPE	-200 ~ 1250°C	Enabled	--	--	--

Click on a specific channel to enable or disable the TC channel. Select the **Enable TC Channel** checkbox and then select the sensor type that meets the physical attachment to the ioLogik E1200.

TC Channel 0 Settings

Enable TC Channel

TC Sensor Type	Range	Unit
E TYPE	-200 ~ 900	°C

Apply to All Channels

Alias Name Settings

Alias Name of Channel

The ioLogik E1200 allows you to calibrate the temperature sensors. Place the sensor in the reference environment, where the temperature is measured by another temperature meter. Follow the instructions and type in the **Reference Value** from the temperature meter's reading. Each calibration requires about 30 seconds per channel. If you do not have another temperature meter, place the sensor in ice water and type in 0 for the Reference Value during the calibration process.

Calibration

Select Channel :

Sensor Type:

Engineering Value:

Reference Value:

1. Ensure the sensor is connected.
2. Ensure the channel and its sensor type is correctly selected.
3. Type in the reference value.
4. Click on the "Calibrate" button.
5. Wait until the page shows "Calibration Completed".

NOTE:

1. Do not remove the sensor from the ice water during calibration.
2. Load factory default will clear the current calibrated settings.

NOTE: Milli-volts types of sensors are not supported to be calibrated.

The ioLogik E1200 allows you to manually adjust the current temperature reading. In each channel configuration section, select the channel, apply the offset value, and click the **Submit** button.

Offset

Channel	Offset	Unit
Select Channel : <input type="text" value="Channel 0"/>	<input type="text" value="1.8"/>	<input type="text" value="°C"/>

NOTE: Offset range: -1000.0 to +1000.0, unit = 0.1 °C/°F.

Peer-to-Peer Networking

In some remote automation implementations, the control room and field sensors may be spread far apart from each other, often with only a single remote I/O module to collect data from all the sensors. Peer-to-peer communication has little or no limitation as it replaces cable by integrating multiple I/O signals over a single network cable to transmit input-to-output controls without the aid of PLCs or controllers. Featuring peer-to-peer communications and support for channel-to-channel mapping, the ioLogik E1200 allows simultaneous multiple target transmissions. In addition, the ioLogik E1200 supports up to 16 channels for transmission over Ethernet (based on an emitter and receiver I/O pair).



NOTE

The peer-to-peer function supports only the ioLogik E1200 Series.

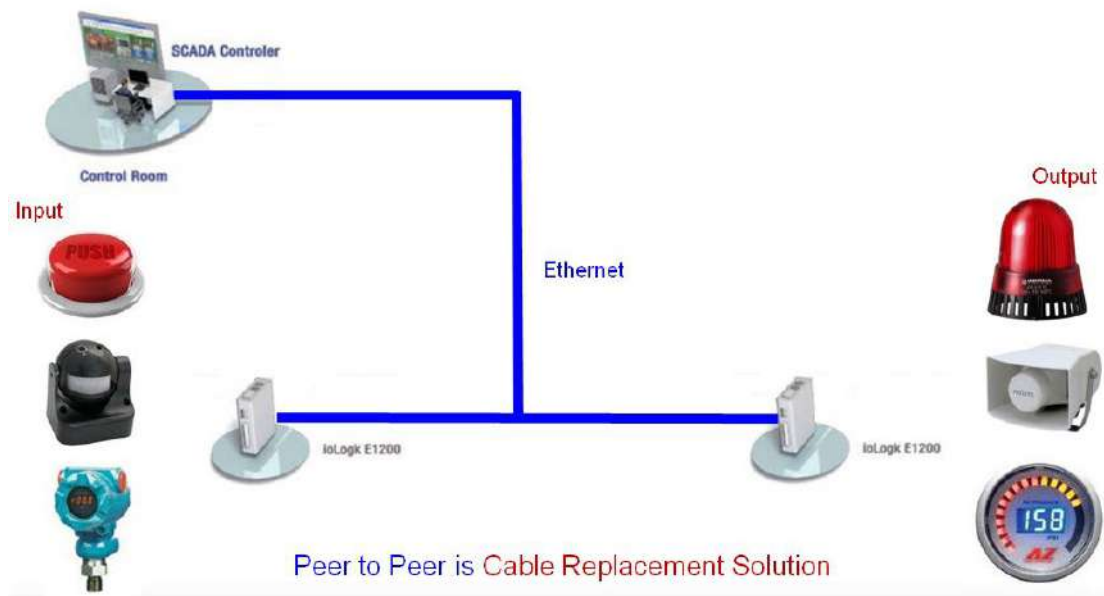

Peer-to-Peer Settings (1-50)

The ioLogik E1200 supports up to 50 peer-to-peer mapping rules. You can configure 10 channel settings at a time. To enable the rules, either select the **Enable All** box to enable all 10 channels or select the **Enable** box individually for each rule. The **Local Channel** dropdown menu allows you to specify the channel of the ioLogik E1200 to configure. Type the IP address and port number of a remote ioLogik E1200 in the **Remote IP** and **Remote Port** fields, respectively. The **Remote Channel** field is for you to select input channels of the remote ioLogik E1200 when you select output channels in the **Local Channel** field. Set the **Interval Time** and **On change** percentage on the local ioLogik E1200 that will trigger the transmission of a mapping signal to the remote ioLogik E1200. The default local listen port number is 9020; this value can be set from 1 to 65535.



NOTE

If you select a DI or AI channel in the Local Channel field, the Remote Channel field will be disabled. You need to configure the DO or AO channel on the remote ioLogik E1200.

Peer to Peer Settings

Enable All

Enable	No.	Local Channel	Remote IP	Remote Port (1-65535)	Remote Channel	Interval Time (500-65535 ms)	On Change	Direction
<input checked="" type="checkbox"/>	1	DI_00	192.168.127.253	9020		<input checked="" type="checkbox"/> 500 ms	<input type="checkbox"/> 1 %	DI -> DO (Peer to)
<input checked="" type="checkbox"/>	2	DI_01	192.168.127.253	9020		<input checked="" type="checkbox"/> 500 ms	<input type="checkbox"/> 1 %	DI -> DO (Peer to)
<input checked="" type="checkbox"/>	3	DI_02	192.168.127.253	9020		<input checked="" type="checkbox"/> 500 ms	<input type="checkbox"/> 1 %	DI -> DO (Peer to)
<input checked="" type="checkbox"/>	4	DI_03	192.168.127.253	9020		<input checked="" type="checkbox"/> 500 ms	<input type="checkbox"/> 1 %	DI -> DO (Peer to)
<input checked="" type="checkbox"/>	5	DI_04	192.168.127.253	9020		<input checked="" type="checkbox"/> 500 ms	<input type="checkbox"/> 1 %	DI -> DO (Peer to)
<input checked="" type="checkbox"/>	6	DI_05		9020		<input checked="" type="checkbox"/> 500 ms	<input type="checkbox"/> 1 %	DI -> DO (Peer to)
<input checked="" type="checkbox"/>	7	DI_06		9020		<input checked="" type="checkbox"/> 500 ms	<input type="checkbox"/> 1 %	DI -> DO (Peer to)
<input checked="" type="checkbox"/>	8	DI_07		9020		<input checked="" type="checkbox"/> 500 ms	<input type="checkbox"/> 1 %	DI -> DO (Peer to)
<input checked="" type="checkbox"/>	9	DI_08		9020		<input checked="" type="checkbox"/> 500 ms	<input type="checkbox"/> 1 %	DI -> DO (Peer to)
<input checked="" type="checkbox"/>	10	DI_09		9020		<input checked="" type="checkbox"/> 500 ms	<input type="checkbox"/> 1 %	DI -> DO (Peer to)

Local Listen Port: (1-65535, Default:9020)
 Heart beat Interval time: sec (0-65535, default = 60, disable = 0)

Heartbeat

The heartbeat interval determines how frequently health-check messages are sent by the device; the heartbeat interval is used to check connectivity from both sides. Once a peer-to-peer server does not receive a heartbeat health-check message from another peer-to-peer client within the pre-defined time period, it will be forced to enter safe mode. To prevent the unintentional triggering of safe mode, the pre-defined time period is calculated by adding the heartbeat interval and a 5-second tolerance (but only if the heartbeat interval is not equal to 0).

Sample Peer-to-peer Configuration

The following is an example of configuring DO (Server IP: 192.168.127.253) to DI (Client IP: 192.168.127.252) peer-to-peer functionality with two ioLogik E1200 devices.

Server Settings:

Peer to Peer Select Setting Table								
Enable	No.	Local Channel	Remote IP	Remote Port	Remote Channel	Interval Time (500-65535 ms)	On Change	Direction
<input checked="" type="checkbox"/>	1	DO_00	192.168.127.252	9020	DI_00	<input type="checkbox"/> 0 ms	<input type="checkbox"/> 1 %	DO <- DI (Peer From)

Client Settings:

For client settings, the **Interval Time** setting and **On Change** percentage setting can be configured.

Peer to Peer Select Setting Table								
Enable	No.	Local Channel	Remote IP	Remote Port	Remote Channel	Interval Time (500-65535 ms)	On Change	Direction
<input checked="" type="checkbox"/>	1	DI_00	192.168.127.253	9020		<input checked="" type="checkbox"/> 500 ms	<input type="checkbox"/> 1 %	DI -> DO (Peer to)

The following table shows the relationship between the number of rules and the maximum frequency with which On Change percentage data can be transmitted.

Number of Rules	DI max. On Change frequency
1	20 Hz
2 to 20	4 Hz
21 to 40	2 Hz
41 to 50	1 Hz

DO Safe Mode Settings

When a peer-to-peer rule on a local DO channel is not valid, or the peer-to-peer connection is down (e.g., the Ethernet wire is unplugged or the device restarts), the local DO channel will enter Safe Mode. You can select **Hold Last**, **ON**, or **OFF** from the **Safe Mode Status** drop-down menu for each DO channel. Once the DO channel enters safe mode, the Safe Status will turn **ON**. Click the **Clear_Safe_Status** button to change the Safe Status back to **NORMAL**. Otherwise, it will remain in the **ON** position.

Peer-to-Peer DO Channels Safe Mode Settings

DO Channel	Mode	Safe Mode Status	Connect Status	Safe Status
DO-00	DO	OFF	OFF LINE	NORMAL
DO-01	DO	OFF	OFF LINE	NORMAL
DO-02	DO	OFF	OFF LINE	NORMAL
DO-03	DO	OFF	OFF LINE	NORMAL

Submit Clear_Safe_Status

AO Safe Mode Settings

When a peer-to-peer rule on a local AO channel is not valid, or the peer-to-peer connection is down (e.g., the Ethernet wire is unplugged or the device restarts), the local AO channel will enter Safe Mode. You can either set the AO channel's Safe Mode Value from 0 to 4095 or enable Hold Last Status during Safe Mode by selecting the checkbox as shown in the following figure. Once the AO channel enters safe mode, the Safe Status will turn to **ON**. Click the **Clear_Safe_Status** button to change the Safe Status back to **NORMAL**. Otherwise, it will remain in the **ON** position.

Peer-to-Peer AO Channels Safe Mode Settings

AO Channel	Mode	Safe Mode Value	Connect Status	Safe Status
AO-00	0-10V	0 (0-4095) <input checked="" type="checkbox"/> Hold Last Status	OFF LINE	NORMAL
AO-01	0-10V	0 (0-4095) <input checked="" type="checkbox"/> Hold Last Status	OFF LINE	NORMAL
AO-02	0-10V	0 (0-4095) <input checked="" type="checkbox"/> Hold Last Status	OFF LINE	NORMAL
AO-03	0-10V	0 (0-4095) <input checked="" type="checkbox"/> Hold Last Status	OFF LINE	NORMAL

Submit Clear_Safe_Status



NOTE

Peer-to-peer safe mode is cleared automatically when the connection returns to normal. However, peer-to-peer safe mode flag needs to be cleared manually by the user. The auto clear safe mode flag only applies to the communication watchdog feature.



NOTE

Please refer to Modbus Address and Register Map in Appendix A. The parameter name is DO_p2pSafeModeFlagClear,
RLY_p2pSafeModeFlagClear,
AO_p2pSafeModeFlagClear

SNMP

The ioLogik E1200 series remote I/O supports SNMPv1 and SNMPv2c for monitoring network I/O devices with SNMP network management software, which is useful for building automation and telecommunications applications.

SNMP Trap

The ioLogik E1200 series remote I/O provides standard SNMP traps and private SNMP traps for I/O devices.

Standard Trap

The ioLogik E1200 series remote I/O provides the following standard SNMP traps:

Trigger Type	Description
coldStart	Sends SNMP trap when the agent reinitializes. *Restart the measurement epochs because configuration data or MIB variables may have changed.
warmStart	Sends SNMP trap when the /etc/snmpd.conf file is reread, and the agent reinitializes. *Do NOT restart the measurement epochs because configuration data or MIB variable values have not changed. The configuration information in the /etc/snmpd.conf file is for agent configurations that do not affect SNMP manager databases.

Private Trap

The ioLogik E1200 series remote I/O provides the following private trap triggers:

Trigger Type	Description
DI-change status	Sends SNMP trap when DI status changes.
DO-change status	Sends SNMP trap when DI status changes.
Relay-change status	Sends SNMP trap when Relay status changes.
AI-burn-out	Sends SNMP trap when AI reaches preset burn-out value.
AI-trigger	Sends SNMP trap when AI reaches preset value.
AO-trigger	Sends SNMP trap when AO reaches preset value.
RTD-trigger	Sends SNMP trap when RTD reaches preset value.
TC-trigger	Sends SNMP trap when TC reaches preset value.



NOTE

You will need to load the correct MIB file to use Moxa's private SNMP traps.

Using SNMP

Moxa has provided the ioLogik E1200 MIB file for easier analysis of SNMP data.

SNMP Agent

You can enable SNMP under **SNMP Settings > SNMP Agent**. SNMP is used to monitor the network and I/O devices with SNMP network management software. Use these fields to enable SNMP and set the read and write community names, contact, and location for SNMPv1 and SNMPv2c.

SNMP Agent

Configurations

SNMP Enable Disable

Read Community Name

Write Community Name

Contact

Location

SNMP Trap Settings

On the SNMP Trap Settings page, you can enable SNMP and configure SNMP traps.

SNMP Trap Server

The SNMP Trap function sends an SNMP trap to up to two IP destinations. If both IP addresses are configured, it will send to both addresses simultaneously when an SNMP trap is triggered.

SNMP Trap Settings

No.	IP Address	Port
1	<input type="text"/>	162
2	<input type="text"/>	162

SNMP Trap

To change the trap community name, type the new name in the input box located to the right of **Trap Community Name**.

Configurations

Trap Community Name

Enable **Channel SNMP Trap** by clicking on the SNMP Trap box, and then select the channel you would like to enable.

DI Channel	Mode	SNMP Trap <input type="checkbox"/>	Specific ID(1-20)	Trigger
DI-00	DI	<input type="checkbox"/>	<input type="text" value="1"/>	On Change
DI-01	DI	<input type="checkbox"/>	<input type="text" value="1"/>	On Change
DI-02	DI	<input type="checkbox"/>	<input type="text" value="1"/>	On Change
DI-03	DI	<input type="checkbox"/>	<input type="text" value="1"/>	On Change
--	--	<input type="checkbox"/>	<input type="text" value="1"/>	--
--	--	<input type="checkbox"/>	<input type="text" value="1"/>	--
--	--	<input type="checkbox"/>	<input type="text" value="1"/>	--
--	--	<input type="checkbox"/>	<input type="text" value="1"/>	--



NOTE

SNMP is not supported while using the peer-to-peer function.

Specific ID

The Specific ID (trap number) can be any number between 1 and 20. (You may need to consult with your network administrator to determine how the trap numbers are used and defined on the network.)

Digital Input / Counter Trap Settings

For a digital input, the trap is triggered by the **On Change** function. When there is a change in the DI channel, the SNMP will send a trap to the SNMP Server.

DI Channel	Mode	SNMP Trap <input checked="" type="checkbox"/>	Specific ID(1-20)	Trigger
DI-00	Counter	<input type="checkbox"/>	<input type="text" value="1"/>	--
DI-01	DI	<input checked="" type="checkbox"/>	<input type="text" value="1"/>	On Change
DI-02	Counter	<input type="checkbox"/>	<input type="text" value="1"/>	--
DI-03	DI	<input checked="" type="checkbox"/>	<input type="text" value="1"/>	On Change



NOTE

SNMP Trap does not support the counter trap function.

Digital Output/Pulse Output Trap Settings

For digital output, the trap is triggered by the **On Change** function. When there is a change in the DO channel, the SNMP will send a trap to the SNMP Server.

DO Channel	Mode	SNMP Trap	Specific ID(1-20)	Trigger
DO-00	DO	<input checked="" type="checkbox"/>	<input type="text" value="1"/>	On Change
DO-01	Pulse Output	<input type="checkbox"/>	<input type="text" value="1"/>	--
DO-02	DO	<input checked="" type="checkbox"/>	<input type="text" value="1"/>	On Change
DO-03	Pulse Output	<input type="checkbox"/>	<input type="text" value="1"/>	--



NOTE

SNMP Trap does not support the Pulse Output trap function.

Analog Input Trap Settings

For Analog Input, the trap is triggered when an analog input meets the preset conditions for Trigger, Value, and Hysteresis. Refer to the AI Channel settings in Chapter 3 to set the mode.

AI Channel	Mode	SNMP Trap	Specific ID(1-20)	Trigger	Value	Hysteresis
AI-00	0-10V	<input checked="" type="checkbox"/>	<input type="text" value="1"/>	Greater	<input type="text" value="0.000"/>	<input type="text" value="0.000"/>
AI-00	0-10V	<input checked="" type="checkbox"/>	<input type="text" value="1"/>	less	<input type="text" value="0.000"/>	<input type="text" value="0.000"/>
AI-01	0-10V	<input checked="" type="checkbox"/>	<input type="text" value="1"/>	Greater	<input type="text" value="0.000"/>	<input type="text" value="0.000"/>
AI-01	0-10V	<input checked="" type="checkbox"/>	<input type="text" value="1"/>	less	<input type="text" value="0.000"/>	<input type="text" value="0.000"/>
AI-02	0-10V	<input checked="" type="checkbox"/>	<input type="text" value="1"/>	Greater	<input type="text" value="0.000"/>	<input type="text" value="0.000"/>
AI-02	0-10V	<input checked="" type="checkbox"/>	<input type="text" value="1"/>	less	<input type="text" value="0.000"/>	<input type="text" value="0.000"/>
AI-03	0-10V	<input checked="" type="checkbox"/>	<input type="text" value="1"/>	Greater	<input type="text" value="0.000"/>	<input type="text" value="0.000"/>
AI-03	0-10V	<input checked="" type="checkbox"/>	<input type="text" value="1"/>	less	<input type="text" value="0.000"/>	<input type="text" value="0.000"/>

Example:

For illustration, consider the following example where we set the AI-00 channel's trigger value to be greater than 5 with a Hysteresis of 1 and smaller than 5 with a Hysteresis of 1.

AI Channel	Mode	SNMP Trap	Specific ID(1-20)	Trigger	Value	Hysteresis
AI-00	0-10V	<input checked="" type="checkbox"/>	<input type="text" value="1"/>	Greater	<input type="text" value="5.000"/>	<input type="text" value="1.000"/>
AI-00	0-10V	<input checked="" type="checkbox"/>	<input type="text" value="1"/>	less	<input type="text" value="5.000"/>	<input type="text" value="1.000"/>

When Trigger = Greater, Value = 5, and Hysteresis = 1, the SNMP trap will only be triggered if the analog signal fluctuates from 4 to 5, as depicted in Scenario 1 below. However, if we change the settings to Value = 5 and Hysteresis = 2, the SNMP trap will only be triggered if the analog signal fluctuates from 3 to 5.

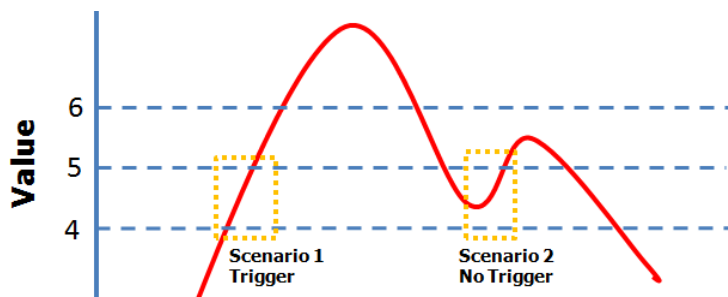

When Trigger = less, Value = 5, and Hysteresis = 1, the SNMP trap will only be triggered if the analog signal fluctuates from 6 to 5, as depicted in Scenario 1 below. However, if we change the settings to Value = 5 and Hysteresis = 2, the SNMP trap will only be triggered if the analog signal fluctuates from 7 to 5.

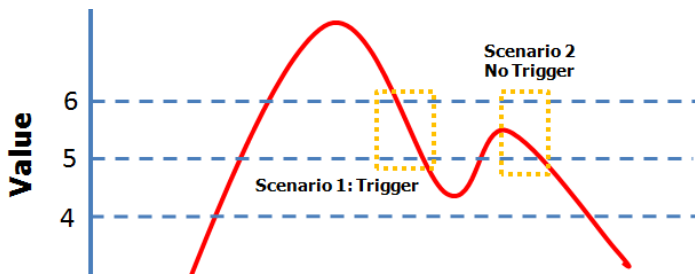

RTD Input Trap Settings

For RTD Input, the trap is triggered when the RTD input meets the preset conditions for Trigger, Value, and Hysteresis. Refer to RTD Channel settings to set the Mode and Range.

RTD Channel	Mode	Range	SNMP Trap <input type="checkbox"/>	Specific ID(1-20)	Trigger	Value	Hysteresis
RTD-00	Resistance	1 ~ 2200(Ω)	<input checked="" type="checkbox"/>	1	Greater	1.0	0.0
RTD-00	Resistance	1 ~ 2200(Ω)	<input checked="" type="checkbox"/>	1	Less	1.0	0.0

Example:

When Trigger = Greater, Value = 400 and Hysteresis = 200, the SNMP trap will only be triggered if the RTD signal fluctuates from 200 to 400, as depicted in Scenario 1 below. However, if we change the settings to Value = 400 and Hysteresis = 400, the SNMP trap will only be triggered if the RTD signal fluctuates from 0 to 400.

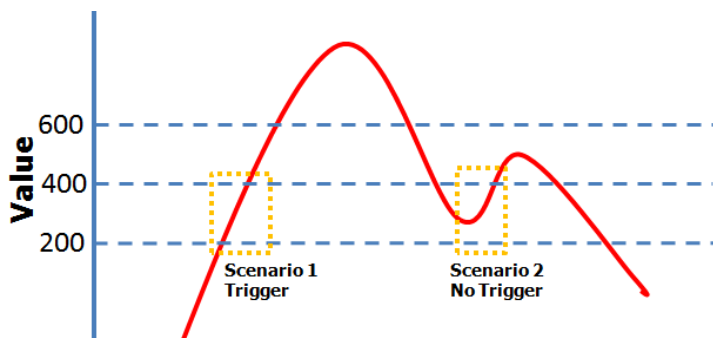

When Trigger = less, Value = 400, and Hysteresis = 200, the SNMP trap will only be triggered if the RTD signal fluctuates from 600 to 400, as depicted in Scenario 1 below. However, if we change the settings to Value = 400 and Hysteresis = 400, the SNMP trap will only be triggered if the RTD signal fluctuates from 800 to 400.

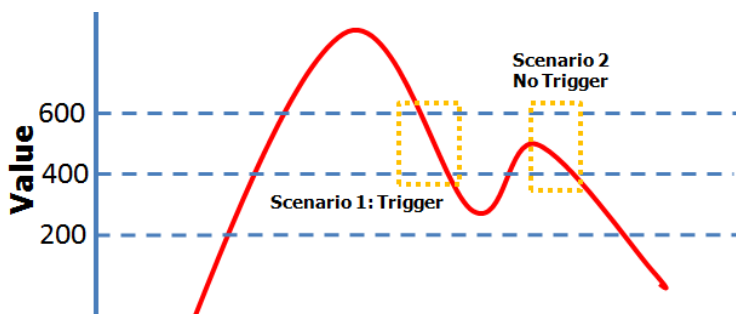

TC Input Trap Settings

For TC Input, the trap is triggered when the TC input meets the preset conditions for Trigger, Value, and Hysteresis. Refer to the TC Channel settings to set the Mode and the Range.

TC Channel	Mode	Range	SNMP Trap <input type="checkbox"/>	Specific ID(1-20)	Trigger	Value	Hysteresis
TC-00	S TYPE	-50 ~ 1760(°C)	<input checked="" type="checkbox"/>	1	Greater	0.0	0.0
TC-00	S TYPE	-50 ~ 1760(°C)	<input checked="" type="checkbox"/>	1	Less	0.0	0.0

Example:

When Trigger = Greater, Value = 400, and Hysteresis = 200, the SNMP trap will only be triggered if the TC signal fluctuates from 200 to 400, like in scenario 1. If we change to Value = 400 and Hysteresis = 400, the SNMP trap will only be triggered if the TC signal fluctuates from 0 to 400.

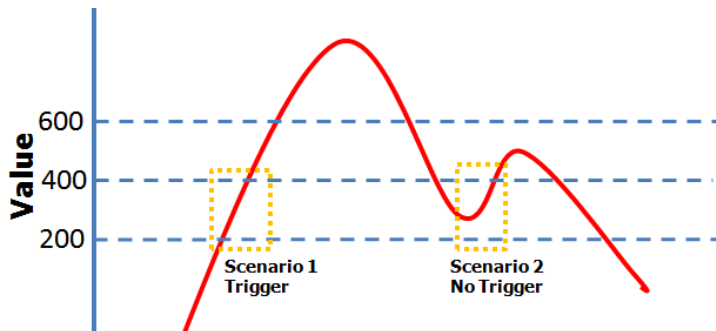

When Trigger = less, Value = 400, and Hysteresis = 200, the SNMP trap will only be triggered if the TC signal fluctuates from 600 to 400, like in scenario 1. If we change to Value = 400 and Hysteresis = 400, the SNMP trap will only be triggered if the TC signal fluctuates from 800 to 400.

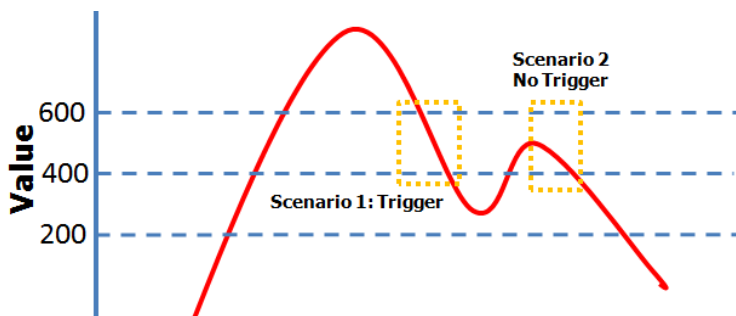

RESTful API Setting

The ioLogik E1200 supports RESTful API. To enable this API, select the Enable Restful API checkbox.

Restful API Settings

Enable Restful API

EtherNet/IP Setting

The ioLogik E1200 supports the EtherNet/IP protocol. To enable the protocol, select the Enable Ethernet/IP Protocol checkbox.



NOTE

The EtherNet/IP function needs to be activated before it can be used. See Chapter 5 for details.

EthernetIP Settings

Enable EthernetIP Protocol

Submit



NOTE

The ioLogik E1200 series only supports EtherNet/IP adapter mode. The maximum number of connections allowed is 9 for read-only, and 1 for read/write.

System Management

Accessibility IP List

You can control network access to the ioLogik E1200 from the **Accessibility IP List** page by enabling access only from specific IP addresses. When the **Enable the accessibility IP list** checkbox is enabled, a host's IP address must be provided and enabled in the list to gain access to the ioLogik E1200.

Accessibility IP List

Enable the accessibility IP List (if unchecked, all connection requests will be accepted.)

No.	Enable	IP Address	Netmask
1	<input checked="" type="checkbox"/>	192.168.127.253	255.255.255.255
2	<input checked="" type="checkbox"/>	192.168.1.0	255.255.255.0
3	<input type="checkbox"/>	0.0.0.0	255.255.255.0
4	<input type="checkbox"/>	0.0.0.0	255.255.255.0
5	<input type="checkbox"/>	0.0.0.0	255.255.255.0
6	<input type="checkbox"/>	0.0.0.0	255.255.255.0
7	<input type="checkbox"/>	0.0.0.0	255.255.255.0
8	<input type="checkbox"/>	0.0.0.0	255.255.255.0
9	<input type="checkbox"/>	0.0.0.0	255.255.255.0
10	<input type="checkbox"/>	0.0.0.0	255.255.255.0

Enable access for a range of IP addresses by specifying the IP address and netmask, as follows:

To allow access to a specific IP address

Enter the IP address in the **IP Address** field and 255.255.255.255 in the **Netmask** field.

To allow access for hosts on a specific subnet

Enter 0 as the last digit in both the **IP Address** field and **Netmask** field (e.g., 192.168.1.0 and 255.255.255.0).

To allow unrestricted access

Deselect the **Enable the accessible IP list** option.

Refer to the following table for additional configuration examples.

Allowed Hosts	IP Address/Netmask
Any host	Disable
192.168.1.120	192.168.1.120 / 255.255.255.255
192.168.1.1 to 192.168.1.254	192.168.1.0 / 255.255.255.0
192.168.0.1 to 192.168.255.254	192.168.0.0 / 255.255.0.0
192.168.1.1 to 192.168.1.126	192.168.1.0 / 255.255.255.128
192.168.1.129 to 192.168.1.254	192.168.1.128 / 255.255.255.128



NOTE

The accessibility IP list can be configured after installing the MXconfig plugin for MXconfig V2.6. For more detailed information regarding MXconfig, please visit Moxa’s website at www.moxa.com.

Password and Login Policy

Users in an administrator role are authorized to determine the password and login policy of the ioLogik E1200 Series.

Account Password and Login Management

Account Password Policy

Password minimum Length (4-16)

Password complexity strength check Enable Disable

At least one digit (0-9) Enable Disable

Mixed upper and lower case letters (A~Z, a~z) Enable Disable

At least one special character (~!@#\$\$%^&*-_!;:,.<>[]{}()) Enable Disable

Account Login Failure Lockout

Account login failure lockout Enable Disable

Retry failure threshold (1-10 retry)

Lockout time (1-60 min)

Account Password Policy

Parameter	Setting	Default	Description
Password minimum length	4-16 characters	4	Define the minimum length of the login password
Password complexity strength check	Enable/Disable	Disable	Enable password complexity strength check will enforce the password combination setting
At least one digit (0 to 9)	Enable/Disable	Disable	The password must contain at least one number (0 to 9) when enabling this parameter
Mixed upper- and lower-case letters (A to Z, a to z)	Enable/Disable	Disable	The password must contain an upper- and lowercase letter when enabling this parameter
At least one special character (~!@#\$\$%^&*-_!;:,.<>[]{}())	Enable/Disable	Disable	The password must contain at least one special character when enabling this parameter

Account Login Failure Lockout

Parameter	Setting	Default	Description
Account login failure lockout	Enable/Disable	Disable	An account login failure lockout rule can be defined and enforced when enabled.
Retry failure threshold	1-10 retry	5	Number of retries can be determined prior to the lockout
Lockout time	1-60 minute(s)	5	Lockout duration can be specified to determine time until next retry.

Notification Message

As an administrator, you are allowed to customize your **Login Message** and the **Login Authentication Failure Message** to notify users with the information you would like to provide them.

Notification Message

Notification Message

Login Message

Welcome to ioLogik

18 characters/Maximum 240 characters

Login Authentication Failure Message

Please contact administrator if login failure

45 characters/Maximum 240 characters

The message will appear on the login page after either a successful login or login failure. See the examples below.



Network Connection

TCP connections from other hosts appear on the Network Connection page. This information can assist you with managing your devices.

Network Connection	
Total TCP/IP Connection(s)	
1	
Source Host Address	Connection Type
192.168.19.201	Web/HTTP

Firmware Update

Load new or updated firmware onto the ioLogik from the Firmware Update page.

Firmware Update

Choose a new firmware file path :

未選擇任何檔案

WARNING:
1. The firmware update process may take a few minutes.
2. NOTE! Once you click the "Update" button, the update process cannot be canceled.
3. DO NOT DISCONNECT POWER OR NETWORK CABLE during the update process, since doing so could cause the firmware to become corrupted.
4. Update only the next or the previous released firmware version to prevent from system failure.



WARNING

To avoid system failure while updating the firmware, follow the instructions given in Appendix I.

Import System Configuration Settings

Import a configuration into the ioLogik server from the Import System Config page. This function can duplicate settings between ioLogik servers. You will be prompted for the location of the configuration file (i.e., "ik1212.txt").

Import System Configuration File

Update network settings (IP, DNS, Gateway, etc.)

Choose a system configuration file path :

WARNING:
1. The file import process could take up to 10 seconds.
2. DO NOT DISCONNECT POWER OR NETWORK CABLE during the upload process, since doing so could cause the system to become corrupted.

Export System Settings

On the **Export System Settings** page, you can export a copy of the ioLogik's configuration file for backup or import it into another ioLogik server.

Export System Settings

Click "[ik1212.txt](#)" to export & save system settings.

Change Password

To change the ioLogik E1200's password protection settings, you will first need to enter the old password. Then, enter the new password in both the **New password** and **Retype password** fields.

Change Password

Password (4 to 16 characters long)

Old password :

New password :

Retype password :



NOTE

Password can only use English letters, numeric, or special characters e.g., ~!@#\$. The default password is **moxa**.



ATTENTION

If you forget the password, the **ONLY** way to configure the ioLogik E1200 is by using the Reset button to load the factory default settings.

Before you change the default password, it is a good idea to export the configuration file when you have finished setting up your ioLogik E1200. Your configuration can then be easily imported back into the ioLogik E1200 if you need to reset the ioLogik E1200 due to a forgotten password or for other reasons.

Load Factory Defaults

This function will reset all the ioLogik E1200's settings to the factory default values. All previous settings, including the console password, will be lost.

Load Factory Default

This function will reset the I/O Server settings to their factory default values. Current settings will be overwritten.

Save/Restart

If you change the configuration, do not forget to reboot the system.

Save/Restart

The configuration has been changed. Click Submit to reboot with the new configuration.

WARNING: Rebooting will disconnect your Ethernet connections and some data loss may occur.

4. Using ioSearch™

This chapter describes ioSearch™, which is used to search for and locate ioLogik E1200 units.

Introduction to ioSearch™

Moxa's ioSearch™ utility is software tool that searches for ioLogik E1200 units on a physical network. The following functions are supported by the ioSearch™ utility:

- Search for and locate ioLogik E1200 units
- Configure IP addresses
- Upgrade firmware for multiple ioLogik E1200 units (same model)
- Export configuration files from multiple ioLogik E1200 units
- Import configuration files from multiple ioLogik E1200 units (same model)
- Reset to default for multiple ioLogik E1200 units
- Activate the EtherNet/IP function for multiple ioLogik E1200 units (you will need to register the device before activating it)

ioSearch™ Main Screen

Main Screen Overview

The main screen displays the results of a broadcast search for ioLogik E1200 units.

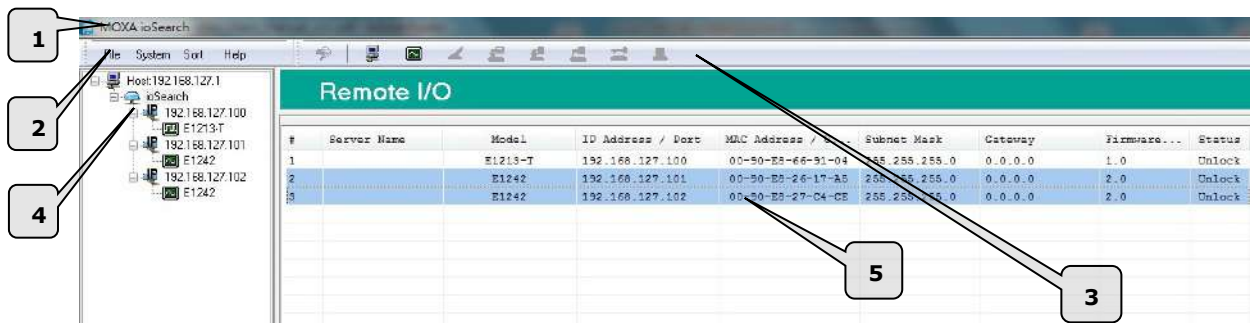

ioSearch™ Main Screen	
1.	Title
2.	Menu bar
3.	Quick link
4.	Navigation panel
5.	Main window

ioSearch™ Setup

System

Several operations are possible from the **System** menu.

Auto Scan Active Ethernet I/O Servers will search for ioLogik servers on the network. When connecting for the first time or recovering from a network disconnection, you can use this command to find I/O servers that are on the network.

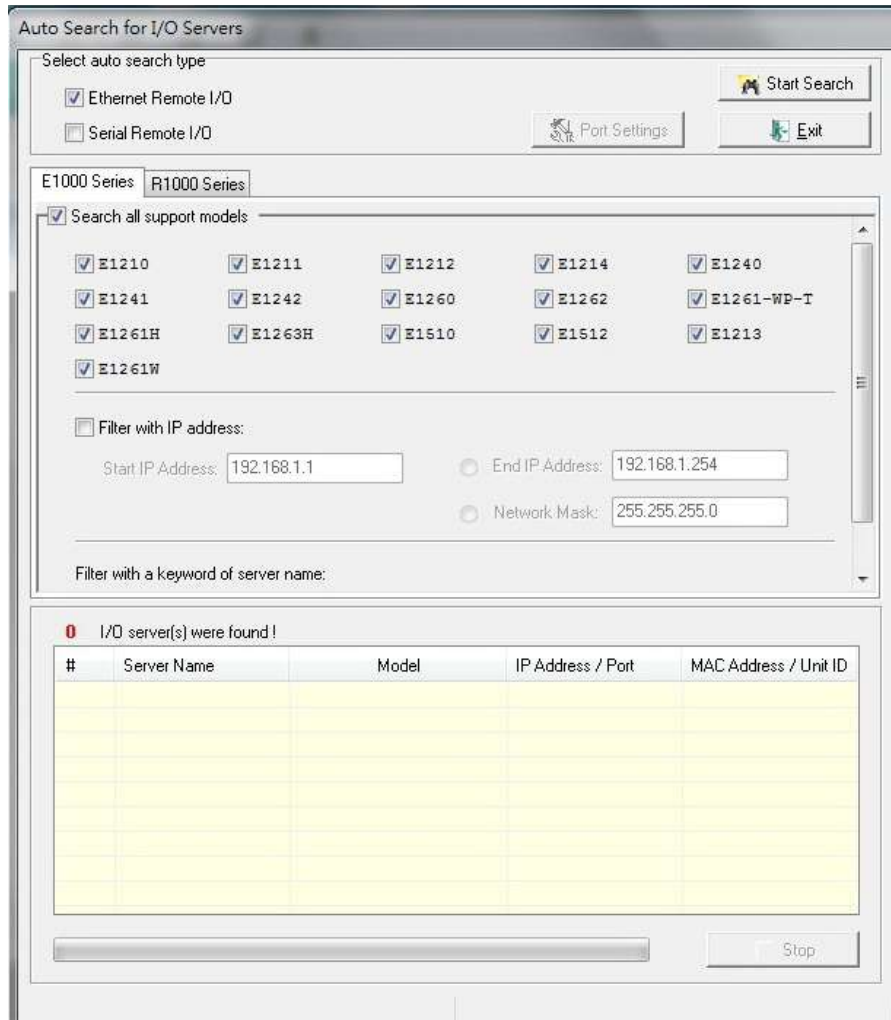

Network Interface allows you to select a network to use, if the PC has multiple network adapters installed.

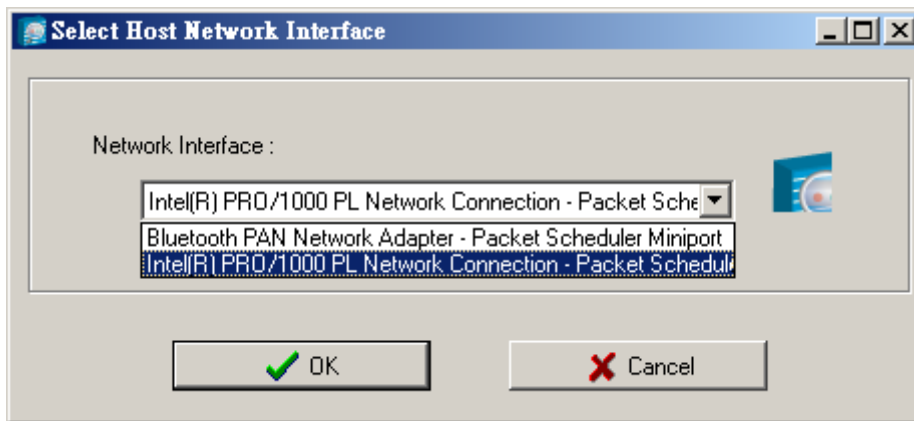

Sort

The **Sort** menu allows the server list in the navigation panel to be sorted by ioLogik connection and server (model).

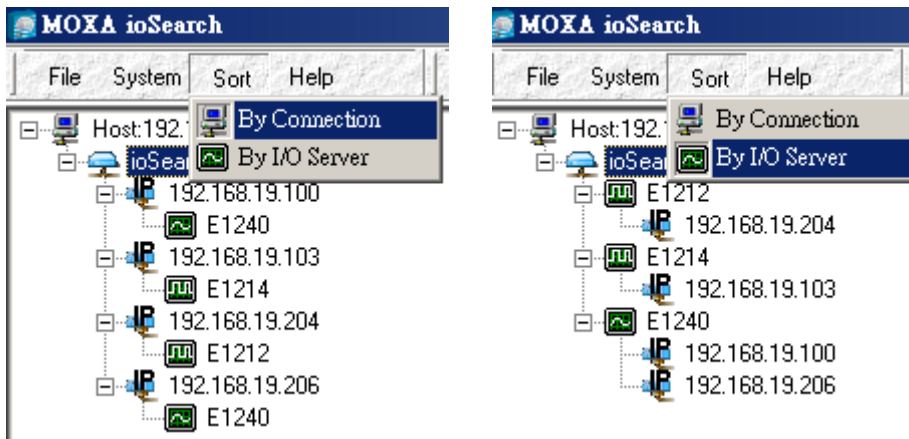

Quick Links

Quick links are provided to search for I/O servers on the network and sort the server list.



1	Automatically search the local network
2	Sort by ioLogik E1200's IP address (connection)
3	Sort by ioLogik E1200 model
4	Locate an ioLogik E1200
5	Upgrade Firmware
6	Import settings
7	Export settings
8	Unlock an ioLogik E1200 which is password protected
9	Change IP Address of an ioLogik E1200

Main Function

Right click on a particular iLogik E1200 to view the ioSearch™ function menu.

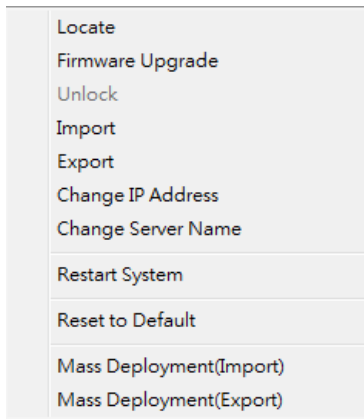

Locate

The locate function helps users find a dedicated iLogik on the network. When this function is triggered, the ready LED on the selected unit will blink, indicating its location.

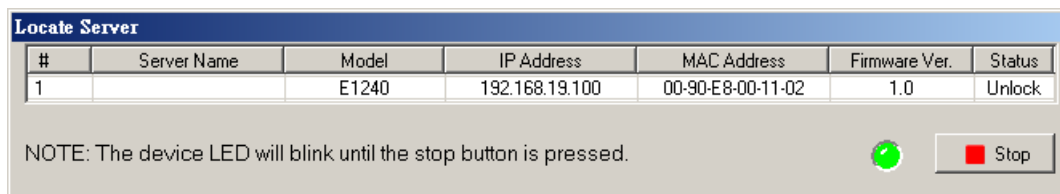

Firmware Upgrade

The iLogik E1200 supports a remote firmware upgrade function. Enter the path to the firmware file or click on the icon to browse for the file. The wizard will lead you through the process until the server is restarted.



NOTE

If your product is using firmware version V3.0 or higher, use ioSearch V2.0 or higher to upgrade to a newer firmware version.

Batch Upgrades on Multiple Devices of the Same Model

Batch firmware upgrades are possible on multiple devices of the same iLogik model. To upgrade multiple models, press the "Shift" key, select "iLogik", and right click to process multiple firmware upgrades.

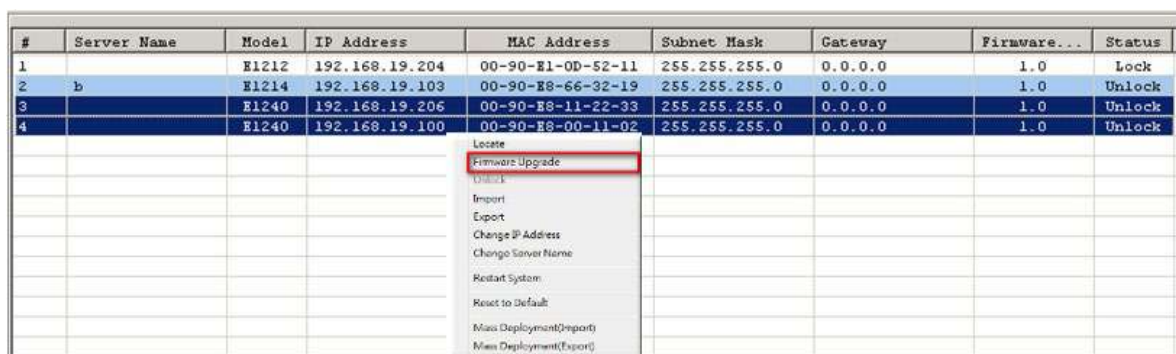



ATTENTION

Do not interrupt the firmware update process! An interruption in the process may cause your device to become unrecoverable.

Unlock

If an ioLogik E1200 is password protected, unlock the ioLogik E1200 by entering the password before using any of the functions.

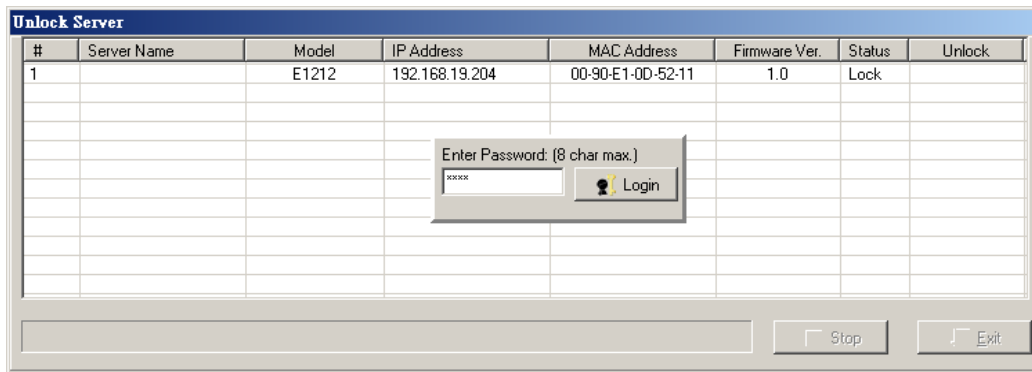

Import

Select this command to reload a configuration that was exported to a text file.

Importing one configuration file to multiple ioLogik E1200 units (same model) is allowed. To do this, press the **"Shift"** key, select **"ioLogik"**, and then right click.

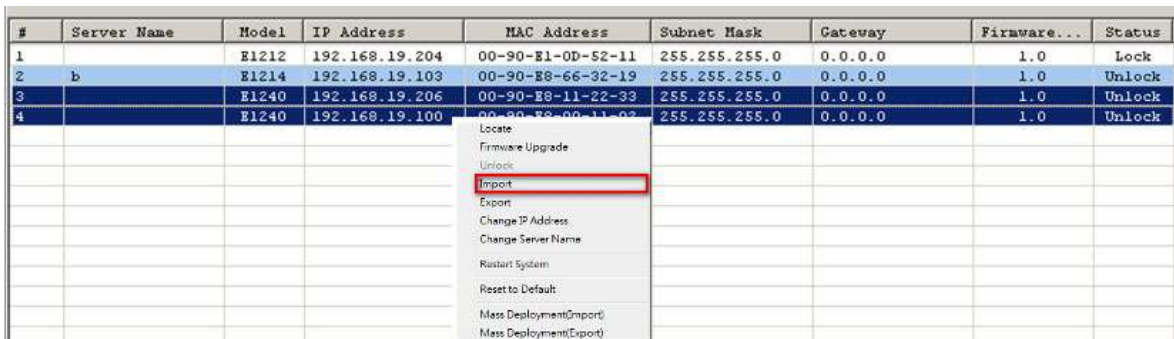

Export

The export function is used to export the current configuration file of an ioLogik E1200. The export file format will be **ik12xx.txt** where "xx" represents the model type of the ioLogik E1200.

Exporting multiple files for different models of ioLogik E1200 is allowed. The file format is **ik12xx_MAC Address.txt**, where the xx represents the model types of the ioLogik E1200.

e.g., ik1214_00-90-E8-66-32-19.txt

To export multiple configuration files, select the ioLogik and right click to process this function.

#	Server Name	Model	IP Address	MAC Address	Subnet Mask	Gateway	Firmware...	Status
1		E1212	192.168.19.204	00-90-E1-0D-52-11	255.255.255.0	0.0.0.0	1.0	Lock
2	b	E1214	192.168.19.103	00-90-E8-66-32-19	255.255.255.0	0.0.0.0	1.0	Unlock
3		E1240	192.168.19.206		255.255.255.0	0.0.0.0	1.0	Unlock
4		E1240	192.168.19.100		255.255.255.0	0.0.0.0	1.0	Unlock

- Locate
- Firmware Upgrade
- Unlock
- Import
- Export
- Change IP Address
- Change Server Name
- Restart System
- Reset to Default
- Mass Deployment(Import)
- Mass Deployment(Export)

Change IP Address

The Change IP Address function allows you to directly modify the IP address for one or multiple ioLogik E1200 series devices and is especially useful for the first-time installation.

First, select the ioLogik E1200 device(s) you wish to modify. Then, right-click on the device(s) and select **Change IP Address** from the drop-down menu to open the Change IP Address window. After changing the IP address, click **Set** to complete setup, and search the network again to reveal the modified IP addresses.

#	Server Name	Model	IP Address	MAC Address	Subnet Mask	Gateway	Firmware...	Status
1		E1212	192.168.19.204	00-90-E1-0D-52-11	255.255.255.0	0.0.0.0	1.0	Lock
2	b	E1214	192.168.19.103	00-90-E8-66-32-19	255.255.255.0	0.0.0.0	1.0	Unlock
3		E1240	192.168.19.206		255.255.255.0	0.0.0.0	1.0	Unlock
4		E1240	192.168.19.100		255.255.255.0	0.0.0.0	1.0	Unlock

- Locate
- Firmware Upgrade
- Unlock
- Import
- Export
- Change IP Address
- Restart System
- Reset to Default

Change IP Address								
#	Server Name	Model	IP Address		MAC Address	Firmware Ver.	Status	Change IP
1	b	E1214	192.168.19.103		00-90-E8-66-32-19	1.0	Unlock	
2		E1240	192.168.19.206	Set	00-90-E8-11-22-33	1.0	Unlock	

Batch TCP/IP Configuration on Multiple Devices

Users can batch modify IP addresses, subnet masks, and gateways for devices of the same model from a single window while submitting the changes at one time. First, select several devices of the same model, click the right mouse button, and then click **Change IP Address** in the pop-up menu to launch a new window.

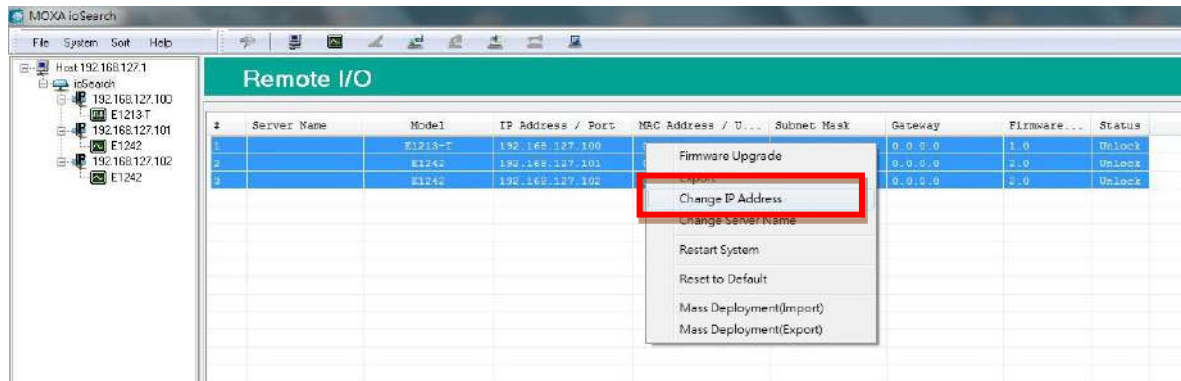

The following screenshot shows the window used to modify IP addresses, subnet masks, and gateways. Users can modify each item and click **Set** to confirm the modification, or click the **Advance** button to automatically assign IP addresses incrementally.

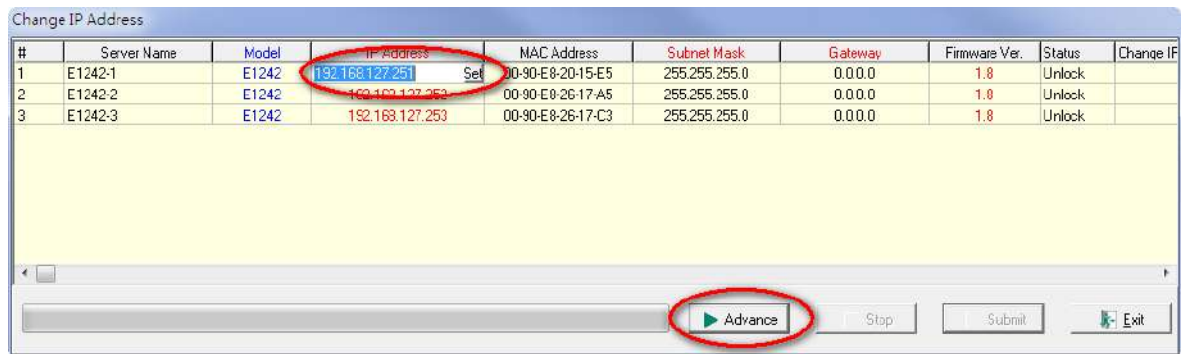

After clicking the **Advance** button, a window will pop up to allow users to use ioSearch™ to set the IP address by MAC address. ioSearch™ will automatically set sequential IP addresses on the selected devices, with the subnet mask and gateway set to the same value.

Change Server Name

To change the server name, click on the **Change Server Name** option, type the name in the **Server Name** box, and then click **Advance**.

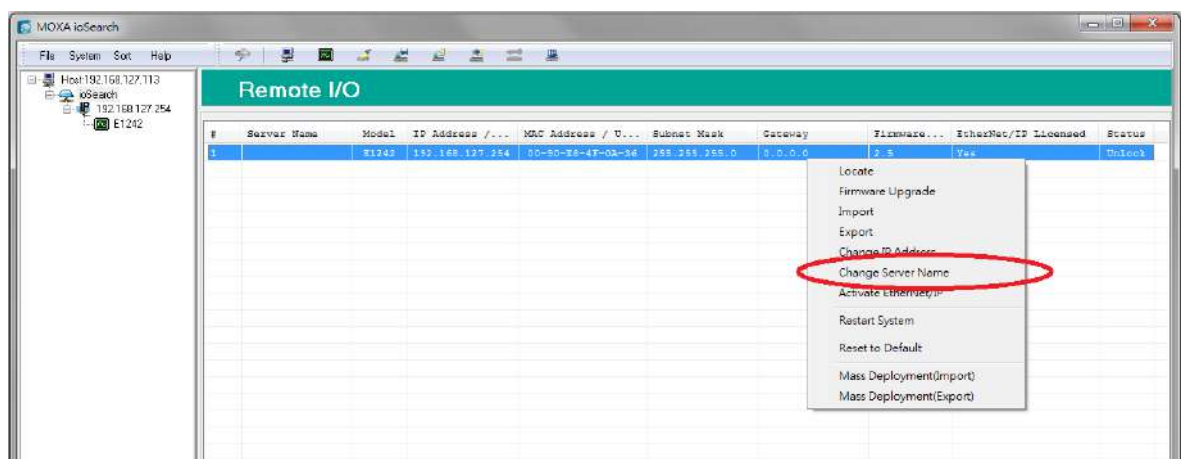

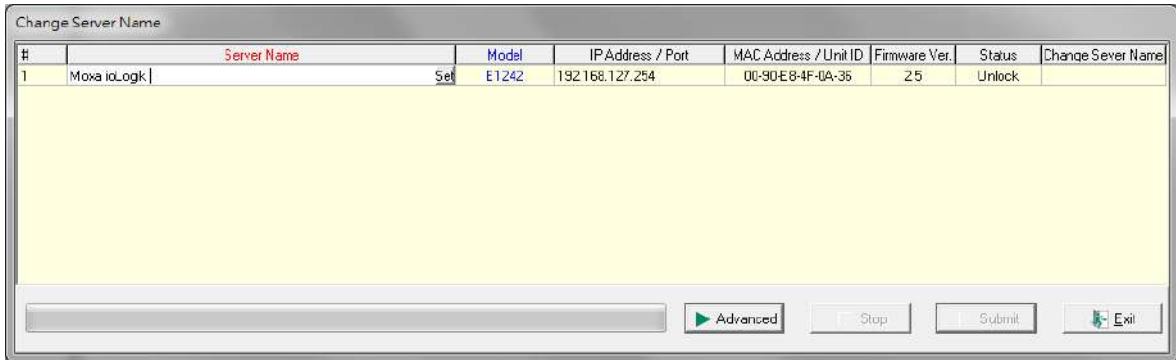

Activate EtherNet/IP

Right click on the device and select **Activate EtherNet/IP**. The progress of the activation process will be shown onscreen, and ioSearch will inform you when the activation has finished.



NOTE

The EtherNet/IP function needs to be activated before it can be used. See Chapter 5 for details.

Restart System

Select this command to restart the selected ioLogik E1200.

Restarting multiple ioLogik E1200 units is allowed. Select the ioLogik E1200 and right click to process this function.

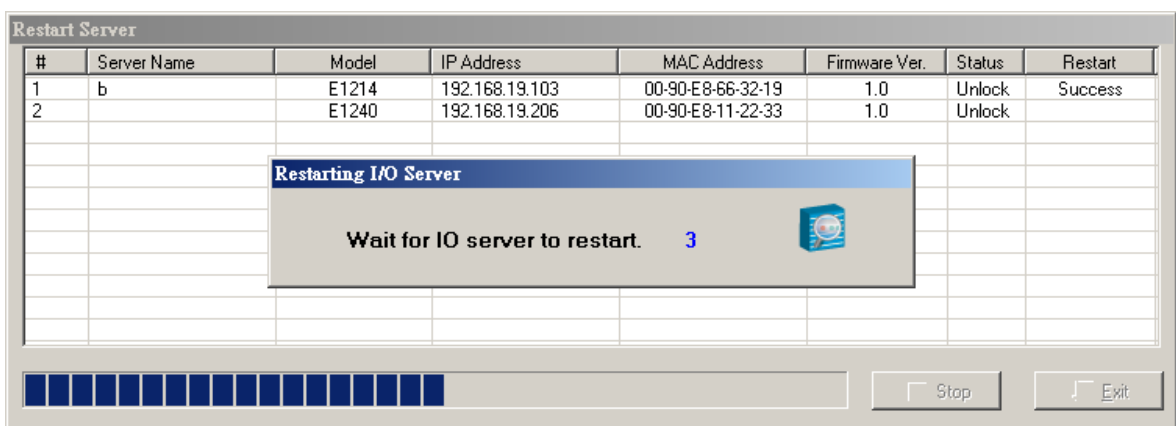
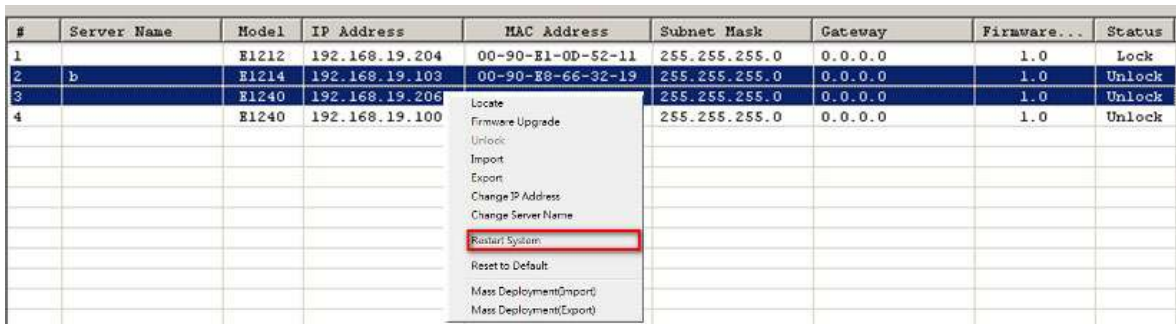

Reset to Default

Select this function to reset all settings, including console password, to factory default values.

Resetting multiple ioLogik E1200 units to the default configuration is allowed. Select the ioLogik E1200 and right click to process this function.

#	Server Name	Model	IP Address	MAC Address	Subnet Mask	Gateway	Firmware...	Status
1		E1212	192.168.19.204	00-90-E1-0D-52-11	255.255.255.0	0.0.0.0	1.0	Lock
2	b	E1214	192.168.19.103	00-90-E8-66-32-19	255.255.255.0	0.0.0.0	1.0	Unlock
3		E1240	192.168.19.206		255.255.255.0	0.0.0.0	1.0	Unlock
4		E1240	192.168.19.100		255.255.255.0	0.0.0.0	1.0	Unlock

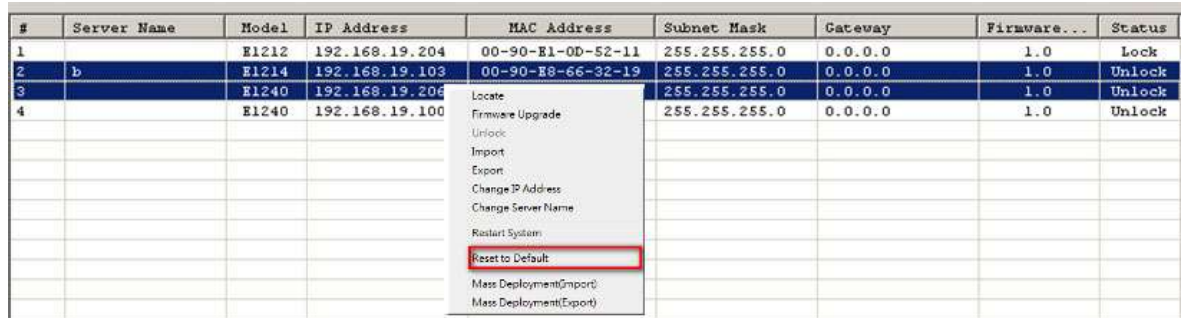

Mass Deployment (Import)

Users can import E1200 series module information via ioSearch™. Select this command to reload a configuration from an exported .CSV file.

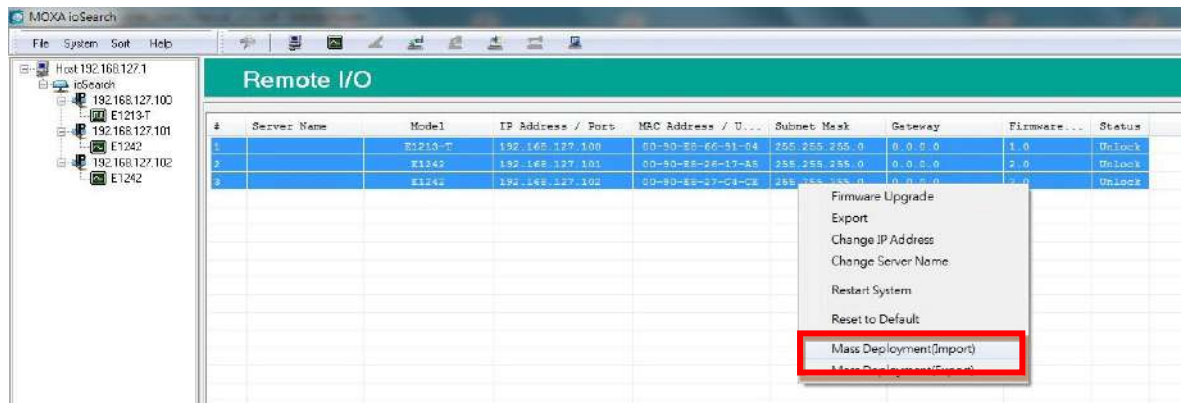

#	Server Name	Model	IP Address / Port	MAC Address / U...	Subnet Mask	Gateway	Firmware...	Status
1		E1213-T	192.168.127.100	00-90-E8-66-31-04	255.255.255.0	0.0.0.0	1.0	Unlock
2		E1242	192.168.127.101	00-90-E8-28-17-A5	255.255.255.0	0.0.0.0	2.0	Unlock
3		E1242	192.168.127.102	00-90-E8-27-C4-C8	255.255.255.0	0.0.0.0	2.0	Unlock

Mass Deployment (Export)

Users can export E1200 series module information via ioSearch™. The export file format will be **E1200_Series_List**.

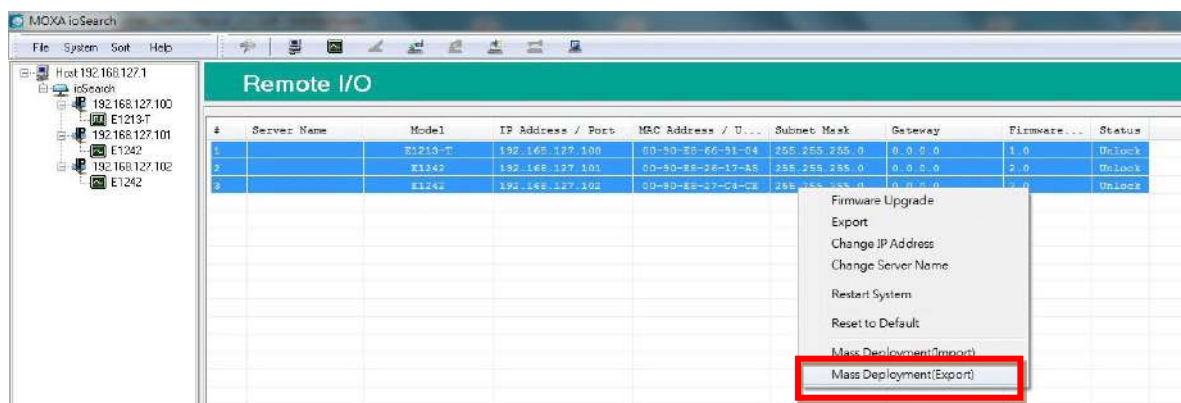

#	Server Name	Model	IP Address / Port	MAC Address / U...	Subnet Mask	Gateway	Firmware...	Status
1		E1213-T	192.168.127.100	00-90-E8-66-31-04	255.255.255.0	0.0.0.0	1.0	Unlock
2		E1242	192.168.127.101	00-90-E8-28-17-A5	255.255.255.0	0.0.0.0	2.0	Unlock
3		E1242	192.168.127.102	00-90-E8-27-C4-C8	255.255.255.0	0.0.0.0	2.0	Unlock

5. Activating the EtherNet/IP Function

The ioLogik E1200 series will support the EtherNet/IP protocol after it has been registered and activated. In this chapter, we explain how to activate the EtherNet/IP function in the ioLogik E1200 series. The EtherNet/IP function can only be activated for firmware and utility versions that are the same as or more recent than those listed below.

Firmware:

- ioLogik E1210 V2.5 (std. version)
- ioLogik E1211 V2.4 (std. version)
- ioLogik E1212 V2.5 (std. version)
- ioLogik E1213 V2.6 (std. version)
- ioLogik E1214 V2.5 (std. version)
- ioLogik E1240 V2.4 (std. version)
- ioLogik E1241 V2.5 (std. version)
- ioLogik E1242 V2.5 (std. version)
- ioLogik E1260 V2.5 (std. version)
- ioLogik E1262 V2.5 (std. version)

Utility:

- ioSearch V1.15 (std. version)



NOTE

If you are using firmware version v3.1 or later, please skip to Step 6 to activate the EtherNet/IP function. For these firmware versions, software license registration is no longer required.

Take the following steps to register a license and activate multiple devices:

Step 1: Assign the license file folder

To assign a folder in which to place the license file, click **System** (**Options** and then click the settings icon to open the following window. Type in the path of the license folder, and then click **OK**.



Step 2: Get the device's serial number

Locate the serial number on the ioLogik E1200 device. The device serial number can be found on the device label, as shown in the picture below.



Step 3: Log in to Moxa's license server

Go to Moxa's Software Licensing website (<http://license.moxa.com>) and log in with your Moxa account and password or apply for an account if this is your first visit to the site.



Step 4: Register the device on the Moxa Licensing Server

On the Software Licensing website, navigate to **Activate Your Software (Software Function (ioLogik E1200 EtherNet/IP))**. First, register a single product by inputting the serial number. Click the **Submit** button to register the product.



Step 5: Download the license file and put it in the designated folder

Download the license file to the folder that was assigned in Step 1, and then unzip the license file.

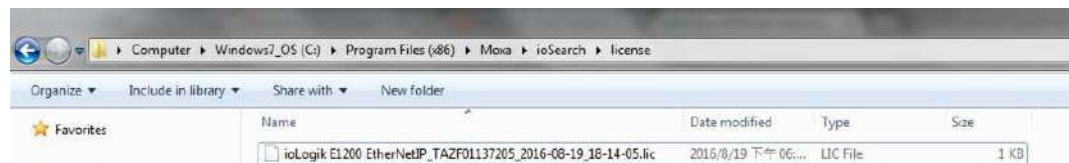

Step 6: Use ioSearch to Activate the EtherNet/IP function in the ioLogik E1200 series

Connect the ioLogik E1200 devices to the computer and use ioSearch to search for the devices. Device information will be displayed in the window. Click the EIP icon in the toolbar to activate multiple devices in the list, or select the unlicensed devices, right click on the devices, and select Activate EtherNet/IP. The progress of the activation process can be viewed, and ioSearch will inform you when the activation is complete.

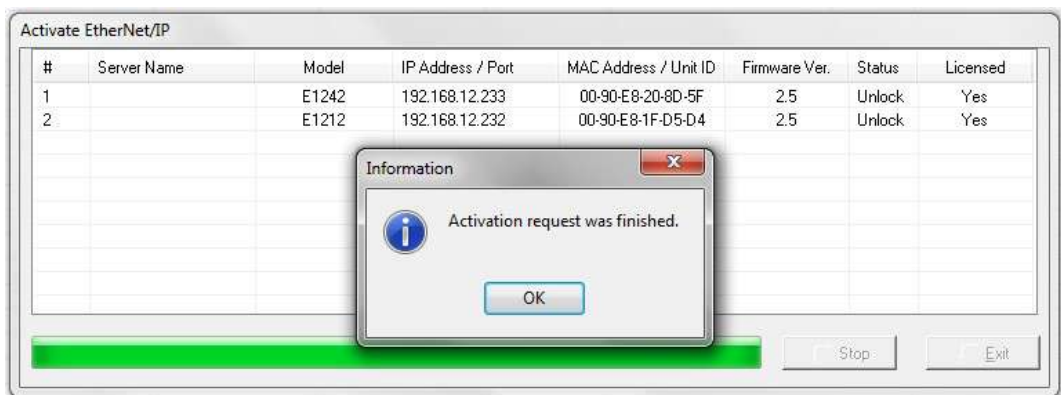
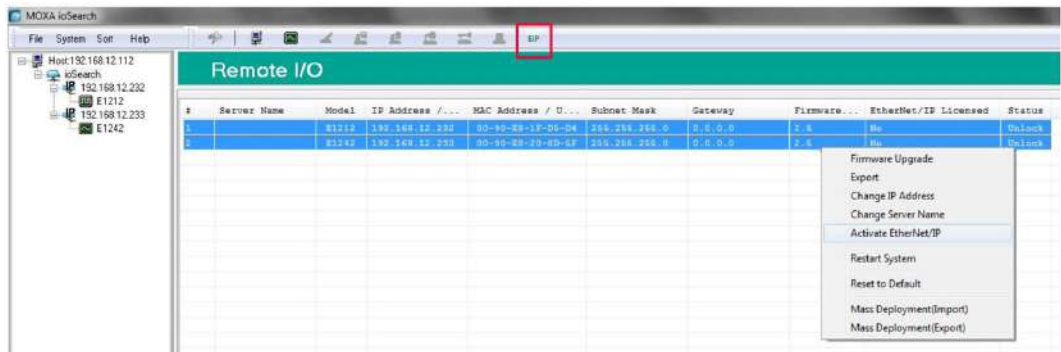

6. How to Connect the ioLogik E1200 to an Allen-Bradley PLC

In this chapter, we provide a step-by-step example of how to connect the ioLogik E1200 series device with an Allen-Bradley PLC by the EtherNet/IP protocol. In this example, the Allen-Bradley PLC is the EtherNet/IP Scanner and the ioLogik E1200 is the adapter. The system architecture is displayed below. There are two sections in this chapter. The first section explains how to install the ioLogik E1200 series' EDS files in the RSLogix 5000, and the second section explains how to connect the ioLogik E1200 with the Allen-Bradley PLC.

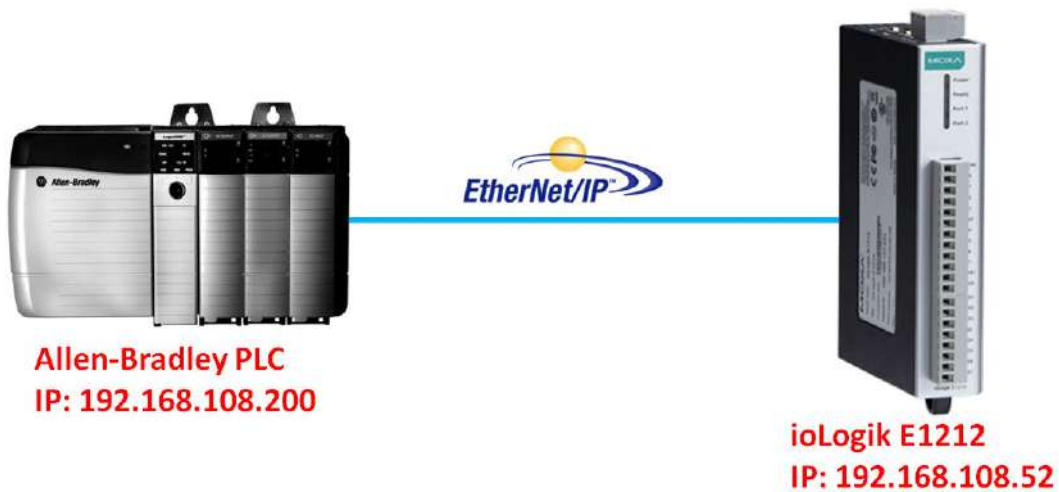

EDS Installation of the ioLogik E1200 Series in Rockwell Software RSLogix 5000

1. Start the RSLogix 5000 and open the EDS Hardware Installation Tool in **Tools > EDS Hardware Installation Tool**.

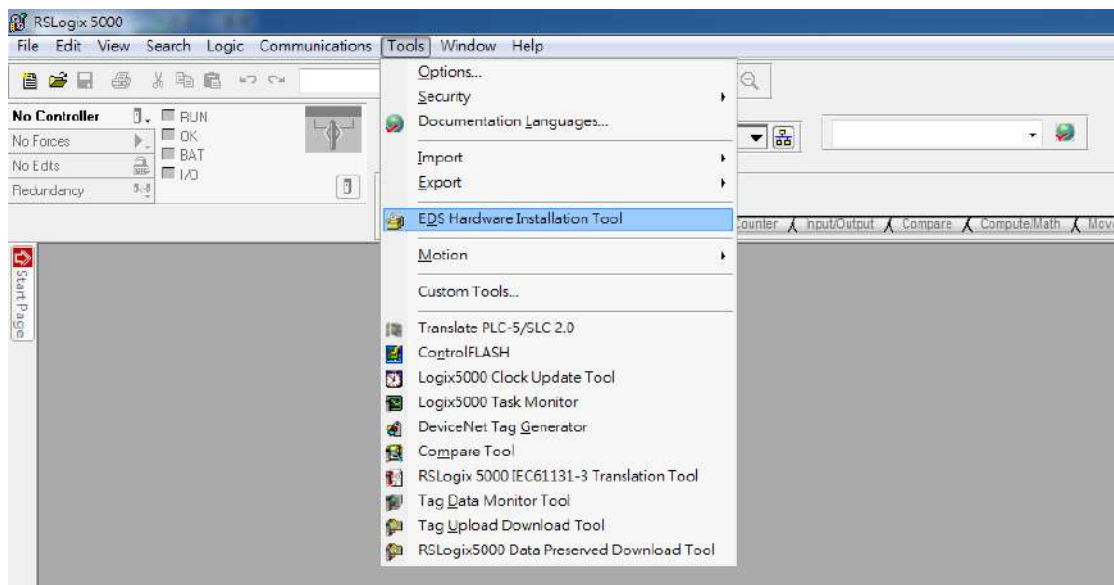

2. The wizard will start, and the following window will pop out, click **Next** and then select Register an EDS file(s), followed by **Next**.

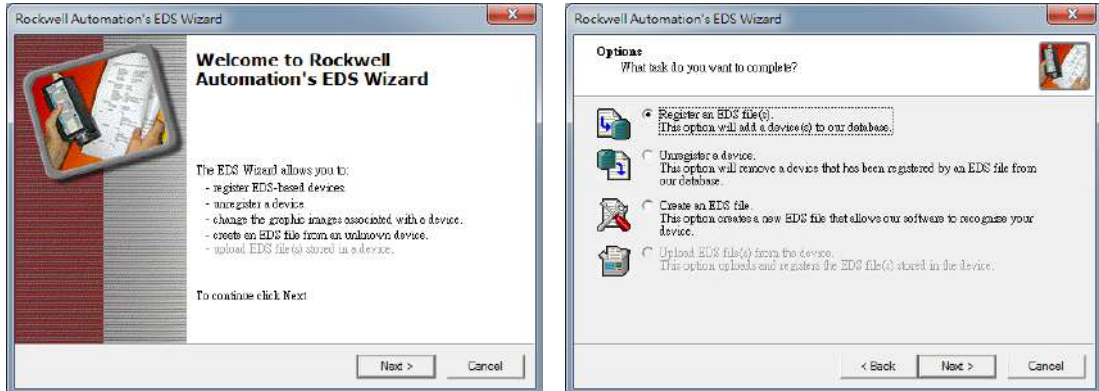

3. There are two ways to register the EDS files. The first is to register a single file, and the second is to register the EDS files by a folder.
 - a. If you want to register one EDS file, select Register a single file and then click Browse.

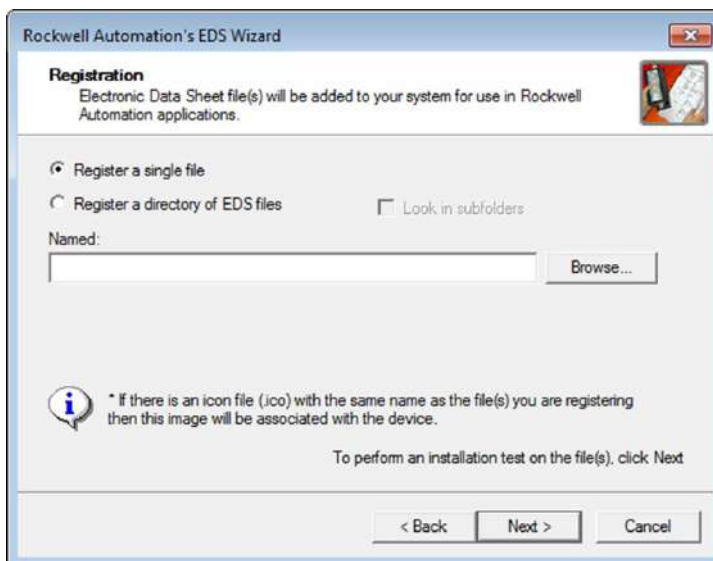

- b. If you want to register several EDS files, put all the EDS files in one folder, select Register a directory of EDS files and then click Browse.

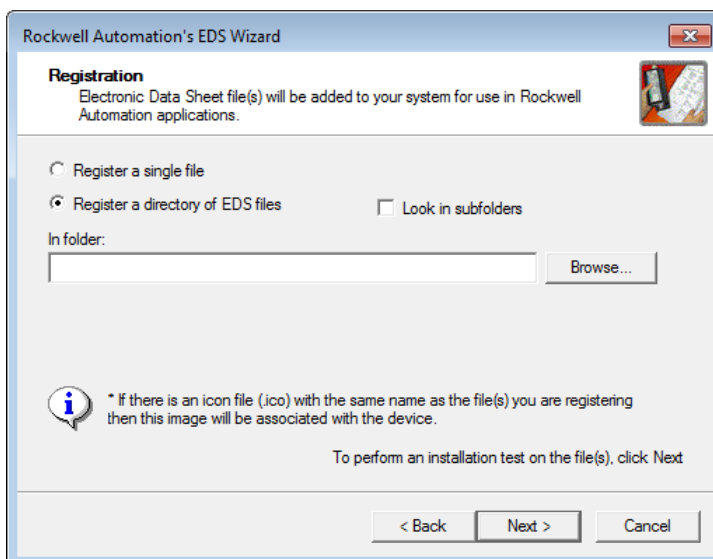

4. Select EDS files and click **Open**, then it will go back to the wizard. Please click **Next** to finish the EDS file selection.
 - a. Single EDS file



- b. Select EDS file folder

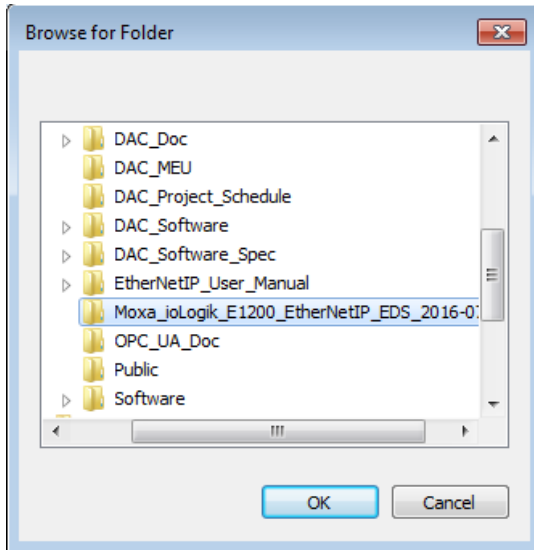

5. The EDS Wizard will evaluate the EDS file you selected and display the result, then click **Next**. In the following window, you can change the device image. If you do not intend to change the image, please click **Next**.

- a. Single EDS file

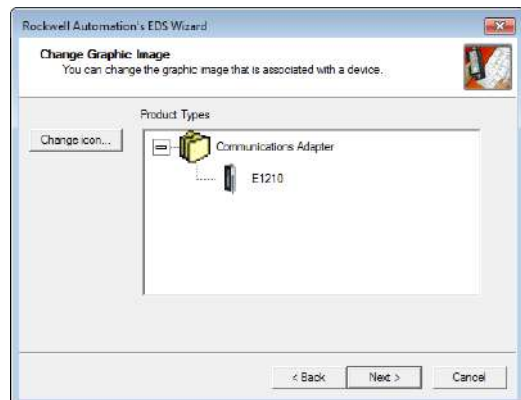
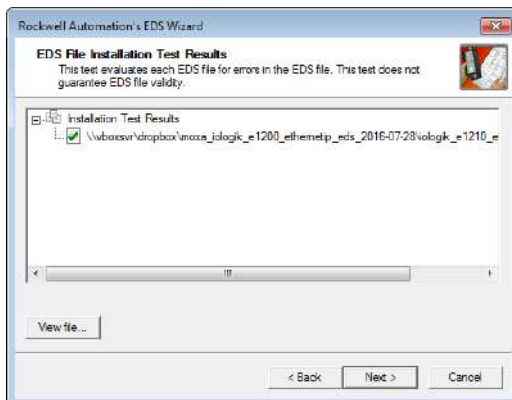

b. EDS files folder

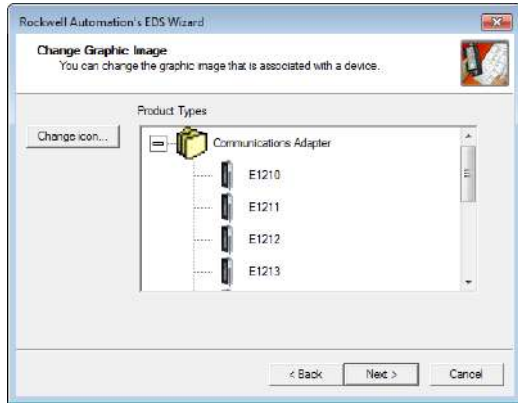
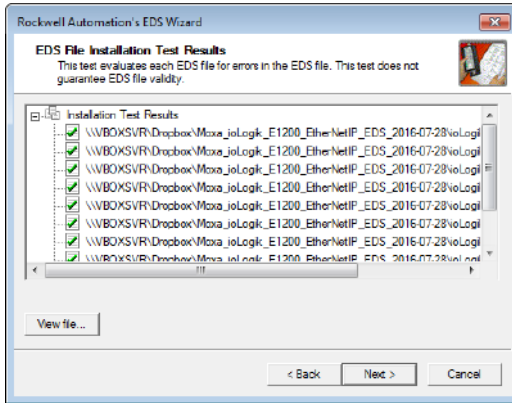

6. Complete the final step of the EDS Wizard by clicking **Next** and then **Finish**.

a. Single EDS file

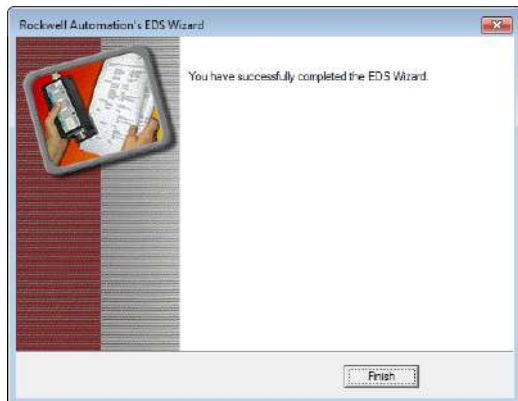
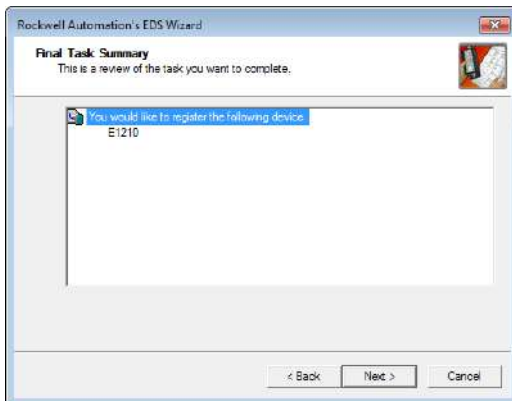

b. EDS files folder

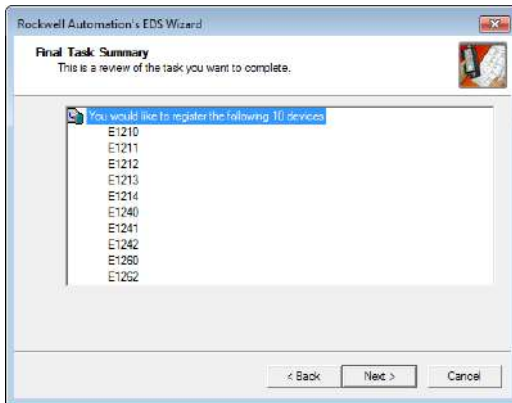

Establishing communication between the ioLogik E1200 device and the Allen-Bradley PLC

1. Open the RSLogix 5000 and then open a new project by pressing **File > New**.

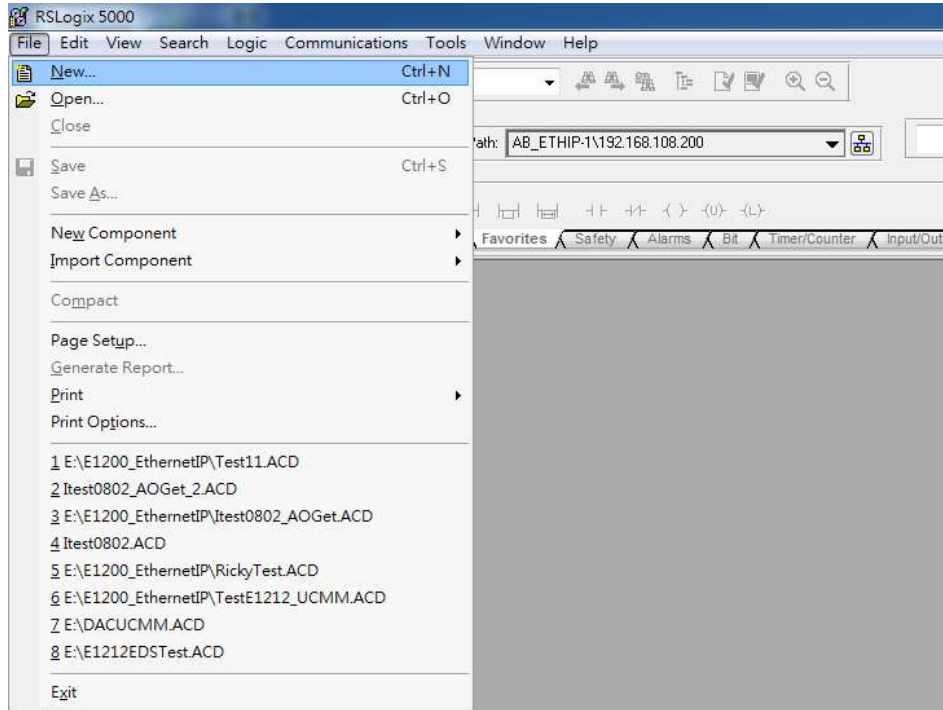

2. Select your PLC model under **Type** and key in the project name in the window. The CompactLogix5324ER-QBFC1B will be used as an example.

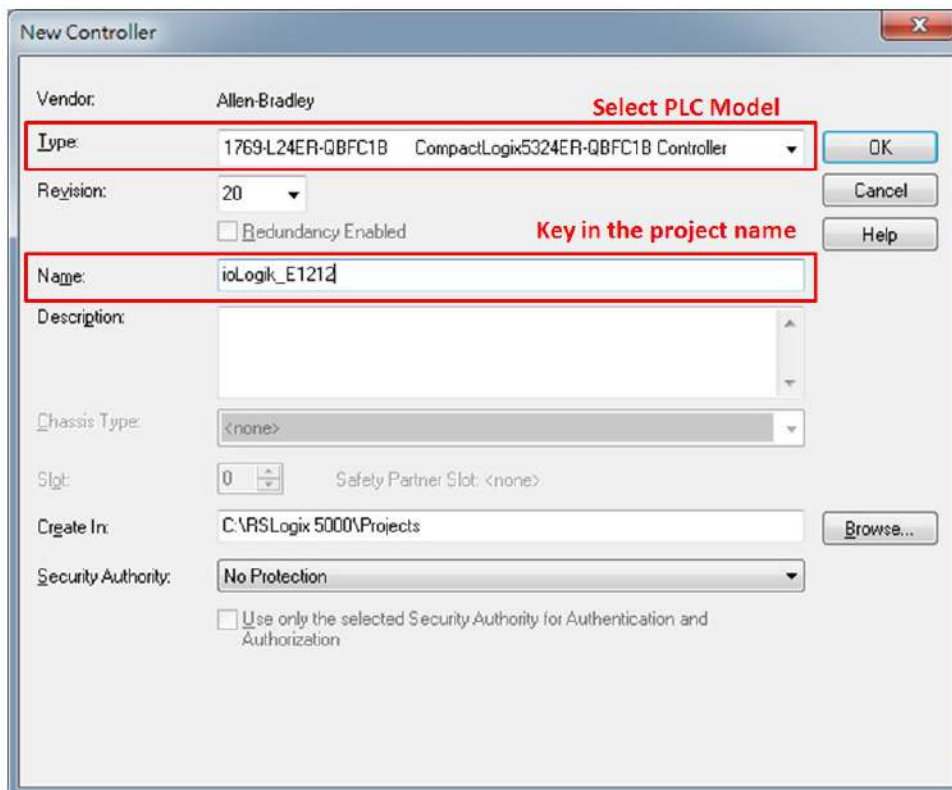

- After the project creation, you can see the project information in the left window. Right click **Ethernet** and then select **New Module** and the ioLogik E1200 module can be added into the project.

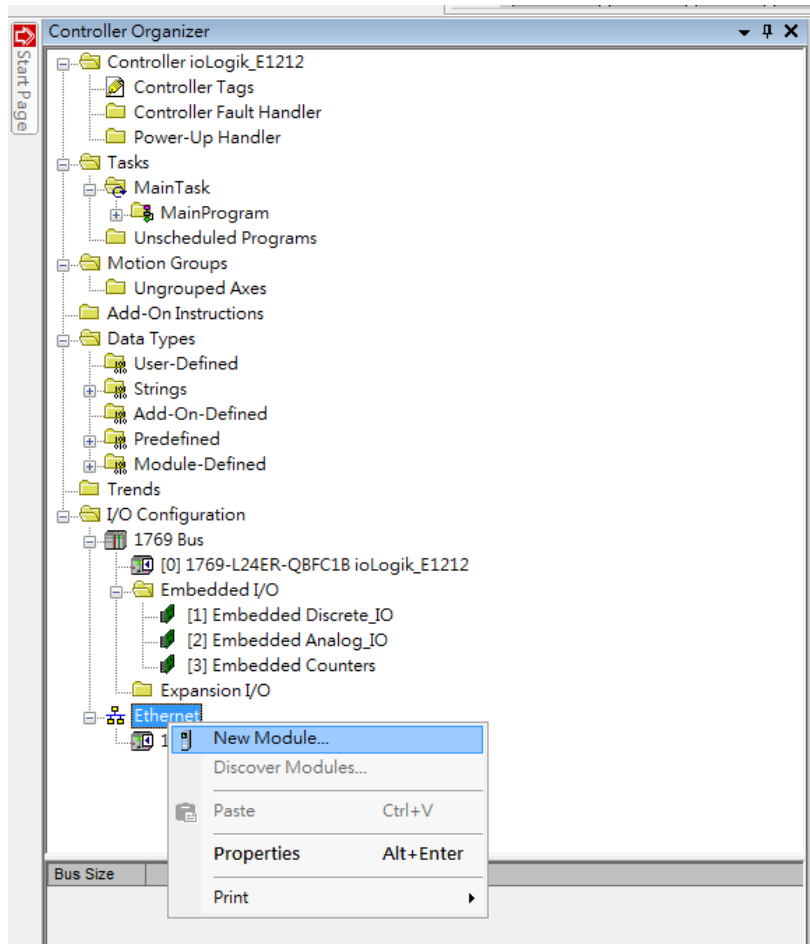

- In the Select Module Type window, choose the ioLogik E1200 model you want to add. You can use a key word and select the module type to speed up the search. The ioLogik E1212 is used here as an example.

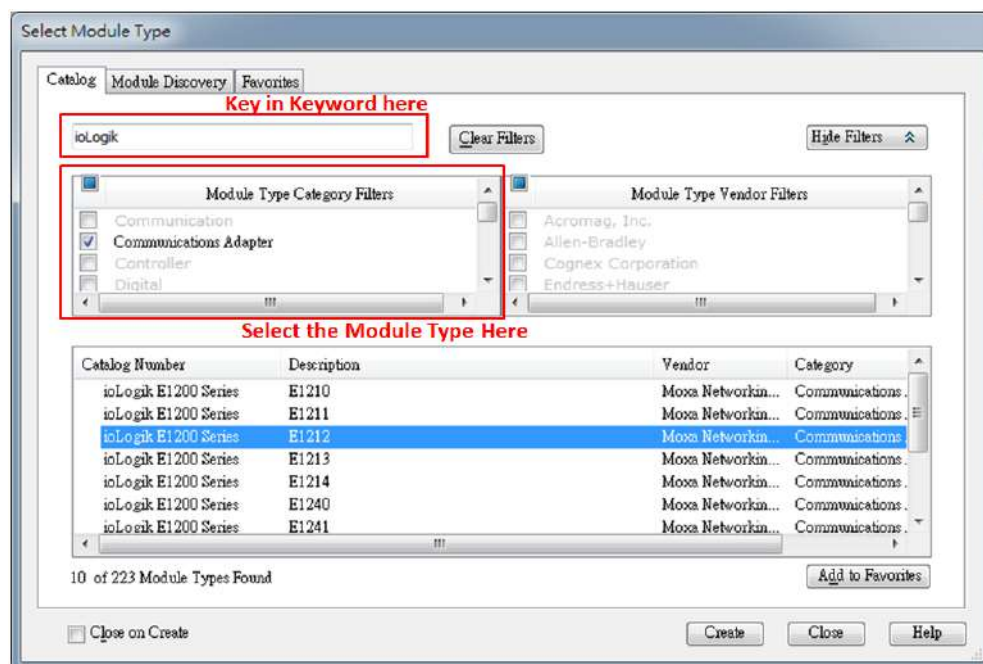

- In the New Module window, key in the module name and module IP. The default module definition is Exclusive Owner. If you want to change it, click change and then choose another type.

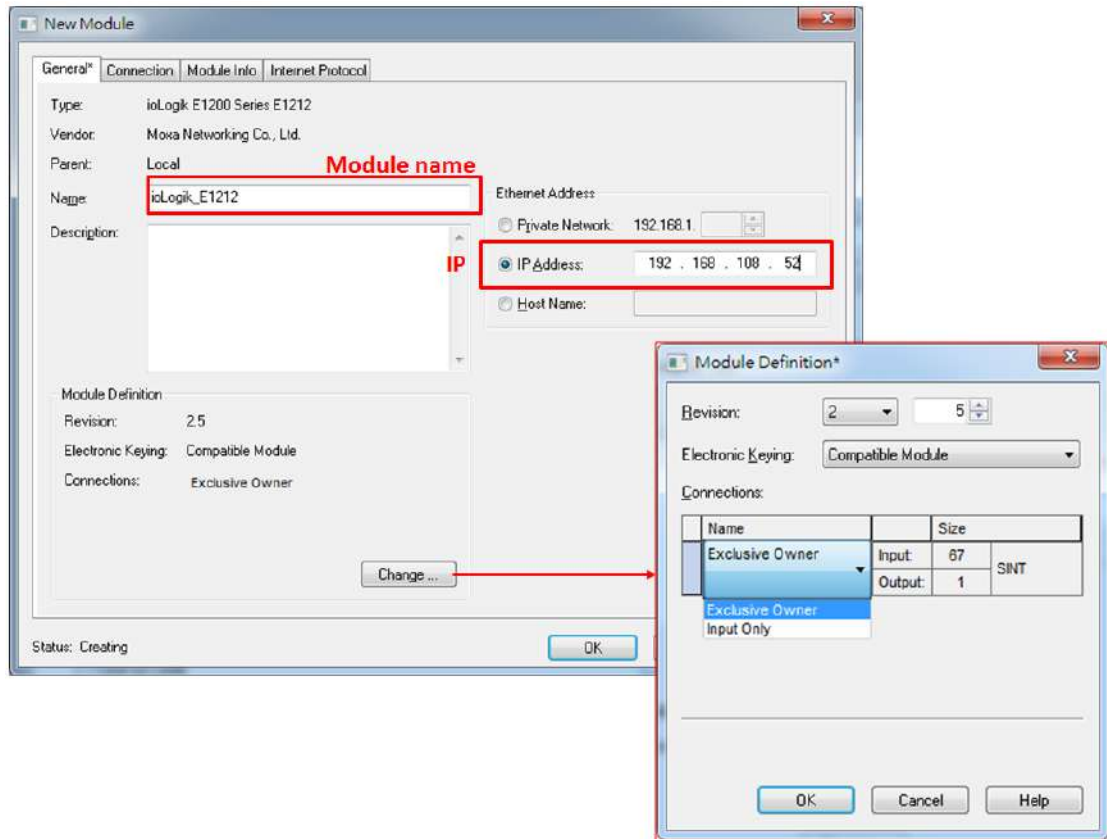

- Key in the Requested Packet Interval settings on the connection panel. To avoid an I/O connection timeout, we recommend setting the requested packet interval (RPI) value for the ioLogik E1200 Series to a number greater than or equal to 100 ms.

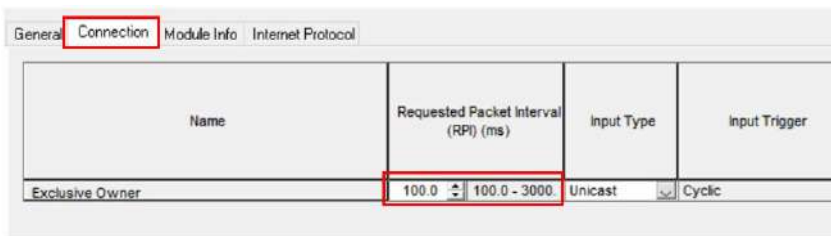

NOTE

The ioLogik E1200 Series is mainly used for data acquisition and remote monitoring, such as recording the ambient temperature and monitoring machine status. The optimal request packet interval (RPI) setting for the ioLogik E1200 Series is 100 ms, which is suitable for the above data acquisition and monitoring requirements.

- RSLogix 5000 will recognize and create the ioLogik E1212 tags automatically. You can check the tag structure in the window.

Name	Value	Force Mask	Style	Data Type	Description	Constant
ioLogik_E1212I		[...]	[...]	_G3DFixLogikE1...		<input type="checkbox"/>
ioLogik_E1212O		[...]	[...]	_G3DFixLogikE1...		<input type="checkbox"/>
Local1.C		[...]	[...]	AB:Embedded_DI...		<input type="checkbox"/>
Local1.I		[...]	[...]	AB:Embedded_DI...		<input type="checkbox"/>
Local1.O		[...]	[...]	AB:Embedded_DI...		<input type="checkbox"/>
Local2.C		[...]	[...]	AB:Embedded_A...		<input type="checkbox"/>
Local2.I		[...]	[...]	AB:Embedded_A...		<input type="checkbox"/>
Local2.O		[...]	[...]	AB:Embedded_A...		<input type="checkbox"/>
Local3.C		[...]	[...]	AB:Embedded_H...		<input type="checkbox"/>
Local3.I		[...]	[...]	AB:Embedded_H...		<input type="checkbox"/>
Local3.O		[...]	[...]	AB:Embedded_H...		<input type="checkbox"/>

8. To download the tag structure to the Allen-Bradley PLC, please go to **Communications (Who Active)** to select the active PLC.

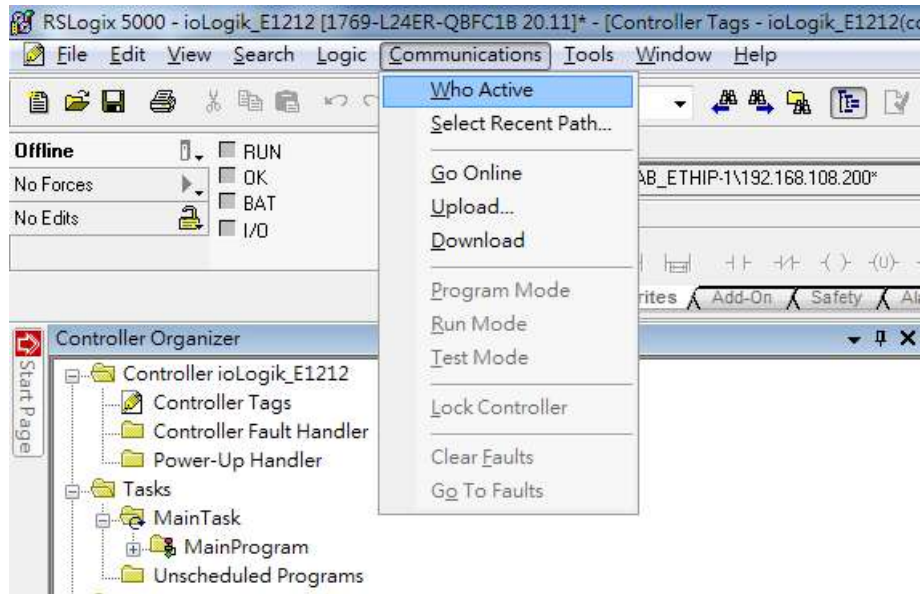

9. Select the PLC in Who Active and then click **Go Online**, followed by **Download**. The RSLogix 5000 will display a pop-up message to inform you the download is complete.

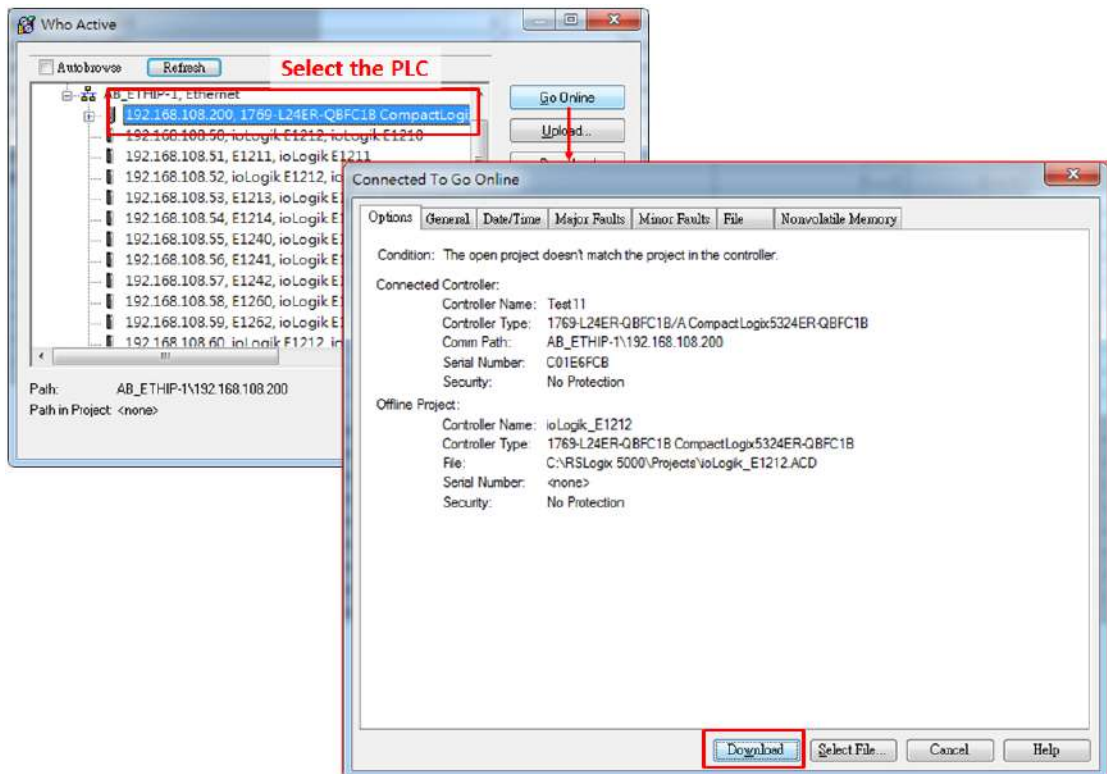

- Change the **ioLogik_E1212.O.Data[0].4** status from 0 to 1 in RSLogix 5000 and the DO-04 status will change from OFF to ON. The ioLogik E1200 will now be successfully connected to the Allen-Bradley PLC.

The screenshot shows the RSLogix 5000 interface with the scope set to ioLogik_E1212. The 'Value' column for ioLogik_E1212.O.Data[0].4 is highlighted with a red box and contains the value '1'. A red arrow points from this value to the 'Status' column of the 'I/O Status' table, which is also highlighted with a red box. The 'I/O Status' table shows that DO-04 is now ON, while all other channels are OFF.

Name	Value	Force Mask	Style	Date Type
ioLogik_E1212I	{...}	{...}		_03DF:ioLogikE1...
ioLogik_E1212O	{...}	{...}		_03DF:ioLogikE1...
ioLogik_E1212.O.Data	{...}	{...}	Decimal	SINT[1]
ioLogik_E1212.O.Data[0]	0		Decimal	SINT
ioLogik_E1212.O.Data[0]0	0		Decimal	BOOL
ioLogik_E1212.O.Data[0]1	0		Decimal	BOOL
ioLogik_E1212.O.Data[0]2	0		Decimal	BOOL
ioLogik_E1212.O.Data[0]3	0		Decimal	BOOL
ioLogik_E1212.O.Data[0]4	1		Decimal	BOOL
ioLogik_E1212.O.Data[0]5	0		Decimal	BOOL
ioLogik_E1212.O.Data[0]6	0		Decimal	BOOL
ioLogik_E1212.O.Data[0]7	0		Decimal	BOOL
Local1.C	{...}	{...}		AB:Embedded_Di...
Local1.I				
Local1.O				
Local2.C				
Local2.I				
Local2.O				
Local3.C				
Local3.I				
Local3.O				

I/O Status		
DI Channel	Mode	Status
DI-00	DI	OFF
DI-01	DI	OFF
DI-02	DI	OFF
DI-03	DI	OFF
DI-04	DI	OFF
DI-05	DI	OFF
DI-06	DI	OFF
DI-07	DI	OFF
DO Channel	Mode	Status
DO-00	DO	OFF
DO-01	DO	OFF
DO-02	DO	OFF
DO-03	DO	OFF
DO-04	DO	ON
DO-05	DO	OFF
DO-06	DO	OFF
DO-07	DO	OFF

7. RESTful API Implementation

The latest firmware versions of ioLogik E1200 series products support a RESTful API protocol. In this chapter, we show how to implement a RESTful API for applications. A RESTful API function can only be activated for firmware and utility versions that are the same as or more recent than those listed below.

Firmware:

- ioLogik E1210 V2.5 (std. version)
- ioLogik E1211 V2.4 (std. version)
- ioLogik E1212 V2.5 (std. version)
- ioLogik E1213 V2.6 (std. version)
- ioLogik E1214 V2.5 (std. version)
- ioLogik E1240 V2.4 (std. version)
- ioLogik E1241 V2.5 (std. version)
- ioLogik E1242 V2.5 (std. version)
- ioLogik E1260 V2.5 (std. version)
- ioLogik E1262 V2.5 (std. version)

Utility:

- ioSearch V1.15 (std. version)

Introduction

Since RESTful APIs are based on HTTP, they are highly compatible with a variety of programming languages (including C# and JavaScript). Consequently, you do not need to learn a new programming language to communicate with Moxa's ioLogik E1200 products. The RESTful API's GET method makes it easy for IT professionals to get data, and the PUT method allows you to easily change the configuration and/or status of your devices.

Configuring RESTful API Settings

Before implementation, three points need to be checked:

1. The RESTful API is active.

To enable the RESTful API, enter the server's IP address in your web browser to access the web console. Under **RESTful Settings**, select the **Enable Restful API** checkbox. Click **Submit** to enable it. It will be activated after saving and restarting the configuration.

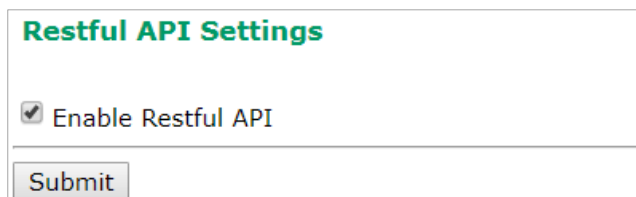

The screenshot shows a web form titled "Restful API Settings". It contains a single checkbox labeled "Enable Restful API" which is checked. Below the checkbox is a "Submit" button.

2. Header information

The operating parameters of http should be specified in the header:

- Accept: vdn.dac.v1
- Content-Type: application/json

3. Supported Methods

Moxa's ioLogik E1200 products support GET, PUT, and OPTIONS methods.

After the settings are ready to go, follow the sample step-by-step instructions on how to use a web service to GET and PUT data.

Using RESTful API via a Web Service

This example uses the Windows 7 OS, with the server configured as follows:

- Note.js: v5.3.0
- Express: v4.15.0

The following flowcharts illustrate how only four steps are needed to implement the GET and PUT methods.

GET: 4 steps (status updated at regular intervals)

GET Request

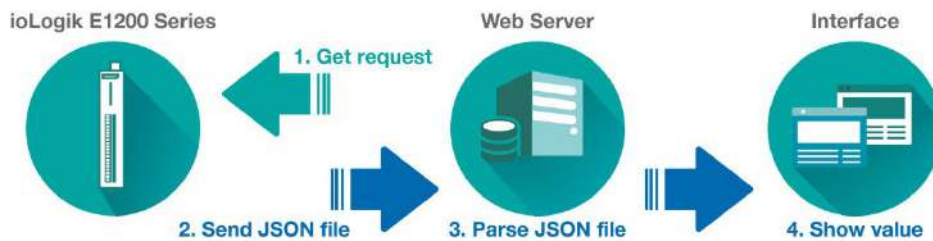

PUT: 4 steps (triggered by command)

PUT Request



1. GET request: The server sends RESTful API GET requests to the ioLogik E1200 to get information.

```
//RESTful Demo: GET request with HTTP Header info
var getIOInfo = function(req, res) {
  var get_request = require('request');
  get_request({
    url: 'http://192.168.127.254/api/slot/0/io/di',
    headers: {
      'Content-Type': 'application/json',
      'Accept': 'vdm.dac.v1'
    }
  }, reqGetCallback);
};
```

PUT request: The server sends RESTful API PUT requests to the ioLogik E1200 to change information.

```
//RESTful Demo: PUT request with HTTP Header info
exports.setDiTable = function(req, res) {
  //Set DI data to json format
  var formData = {};
  formData = req.body;
  jsonData = JSON.stringify(formData);

  //PUT request
  var put_request = require('request');
  put_request({
    method: 'PUT',
    url: 'http://192.168.127.254/api/slot/0/io/di',
    headers: {
      'Accept': 'vdn.dac.v1',
      'Content-Type': 'application/json',
      'Content-Length': Buffer.byteLength(jsonData)
    },
    body: jsonData //set data to PUT request content
  }, reqPutCallback);
};
```



NOTE

When sending requests, headers should be included to ensure that the RESTful API is implemented successfully. Headers should include the following information:

- Accept: vdn.dac.v1
- Content-Type: application/json

2. Send JSON file: The ioLogik E1200 sends a response to the server in JSON format.
3. Parse JSON file: The content is parsed and saved by the server.

```
//Get & parse DI json table
function reqGetCallback(error, resp, body) {
  if(!error && resp.statusCode == 200) { //request success

    restTable = {};
    diInfoList = [];
    var info = JSON.parse(body); //parse HTTP content to json
    restTable = info;
    diInfoList= info.io.di; //save IO-DI info to server
  }
  else
  {
    diInfoList = [];
    diInfoList = defaultDiList;
  }
};
```

- Show value: The information can be displayed in various interfaces. Here, we take a web browser as an example:

GET: Show current I/O status

DI Group

DI-00

Index	0
Mode	Counter Mode
Status	START

PUT: The counter status will be changed from START to STOP.

DI Group

DI-00

Index	0
Mode	Counter Mode
Status	STOP

Troubleshooting Reference

The ioLogik E1200 series supports various combinations of I/O points. To get detailed data structure information for troubleshooting, use the ioSearch utility's built-in help tool.

Path: **Help > ioSearch Help > RESTful API > ioLogik E1200 RESTful API**

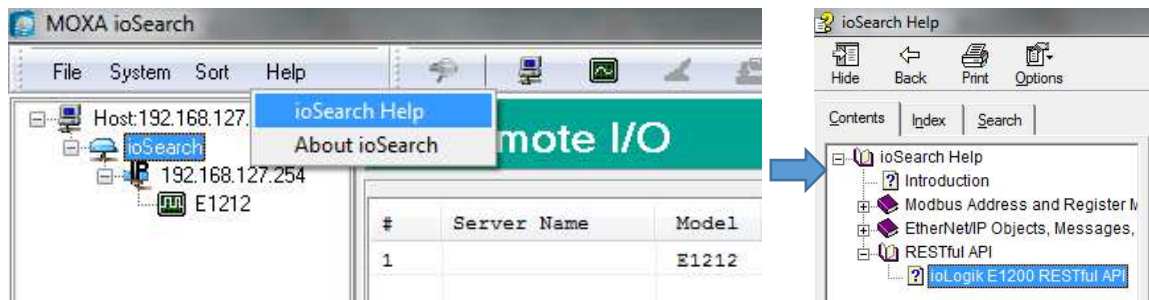

In this help file, users can find information such as data type, data structure, supported methods, and response codes.



NOTE

For more RESTful API Technical and Setting details, please refer to "Tech Note: Using a RESTful API to Connect to Remote I/Os"

A. Modbus/TCP Default Address Mappings



NOTE

The Modbus/TCP ID of the ioLogik E1200 is set to "1" by default.

Supported Function Code

Point Type	Register (Decimal)	Access	Type	Supported Function Code
01: COIL STATUS	0xxxx	R/W	bit	1, 5, 15
02: INPUT STATUS	1xxxx	R	bit	2
03: HOLDING REGISTER	4xxxx	R/W	word	3, 6, 16
04: INPUT REGISTER	3xxxx	R	word	4

ioLogik E1210 Modbus Address and Register Map

I/O

Parameter Name	Description	Start Address (decimal)	Point Type	Start Register (decimal)	Length	Access	Type
DI_counterOverflowFlag	0: Normal, 1: Overflow	1000	02:INPUT STATUS	11001	16	R	bit
DI_counterOverflowFlagClear	1: clear overflow flag	0288	01:COIL STATUS	00289	16	R/W	bit
DI_counterReset	1: reset to initial value	0272	01:COIL STATUS	00273	16	R/W	bit
DI_counterStatus	0: STOP, 1: START	0256	01:COIL STATUS	00257	16	R/W	bit
DI_counterValue	high/low word	0016	04:INPUT REGISTER	30017	32	R	2 words
DI_status	0: OFF, 1: ON	0000	02:INPUT STATUS	10001	16	R	bit
DI-all_statusFromDI-00	0: OFF, 1: ON	0048	04:INPUT REGISTER	30049	1	R	word

System

Parameter Name	Description	Start Address (decimal)	Point Type	Start Register (decimal)	Length	Access	Type
deviceName	Each byte represents ASCII code of each character	5040	04:INPUT REGISTER	305041	30	R	word
deviceUpTime	unit: sec(s)	5020	04:INPUT REGISTER	35021	2	R	word
firmwareVersion	e.g., V1.2.3 -> 1st byte: 1, 2nd byte: 2, 3rd byte: 3	5029	04:INPUT REGISTER	35030	2	R	word
firmwareBuildDate	e.g., Build16051718 --> 16051718	5031	04:INPUT REGISTER	35032	2	R	word
lanIp	e.g., 192.168.127.254 -> 1st byte: 192, 2nd byte: 168, 3rd byte: 127, 4th byte: 254	5027	04:INPUT REGISTER	35028	2	R	word
lanMac	e.g., 00:90:E8:3E:18:CC -> 1st byte: 0, 2nd byte: 144, 3rd byte: 232, 4th byte: 62, 5th byte: 24, 6th byte: 204	5024	04:INPUT REGISTER	35025	3	R	word
modelName	Each byte represents ASCII code of each character	5000	04:INPUT REGISTER	35001	10	R	word

ioLogik E1211 Modbus Address and Register Map

I/O

Parameter Name	Description	Start Address (decimal)	Point Type	Start Register (decimal)	Length	Access	Type
DO_p2pSafeModeFlag Clear	1: clear safe mode flag	4128	01: COIL STATUS	04129	16	R/W	bit
DO_p2pSafeModeFlag	0: OFF, 1: ON	4112	02: INPUT STATUS	14113	16	R	bit
DO_p2pStatus	0: OFF, 1: ON	4096	02: INPUT STATUS	14097	16	R	bit
DO_pulseCount		0036	03: HOLDING REGISTER	40037	16	R/W	word
DO_pulseOffWidth	unit: 1 ms	0068	03: HOLDING REGISTER	40069	16	R/W	word

Parameter Name	Description	Start Address (decimal)	Point Type	Start Register (decimal)	Length	Access	Type
DO_pulseOnWidth	unit: 1 ms	0052	03: HOLDING REGISTER	40053	16	R/W	word
DO_pulseStatus	0: STOP, 1: START	0016	01: COIL STATUS	00017	16	R/W	bit
DO_status	0: OFF, 1: ON	0000	01: COIL STATUS	00001	16	R/W	bit
DO-all_statusFromDO-00	0: OFF, 1: ON	0032	03: HOLDING REGISTER	40033	1	R/W	word

System

Parameter Name	Description	Start Address (decimal)	Point Type	Start Register (decimal)	Length	Access	Type
deviceName	Each byte represents ASCII code of each character	5040	04: INPUT REGISTER	35041	30	R	word
deviceUpTime	unit: sec(s)	5020	04: INPUT REGISTER	35021	2	R	word
firmwareVersion	e.g., V1.2.3 -> 1st byte: 1, 2nd byte: 2, 3rd byte: 3	5029	04: INPUT REGISTER	35030	2	R	word
firmwareBuildDate	e.g., Build16051718 --> 16051718	5031	04: INPUT REGISTER	35032	2	R	word
lanIp	e.g., 192.168.127.254 -> 1st byte: 192, 2nd byte: 168, 3rd byte: 127, 4th byte: 254	5027	04: INPUT REGISTER	35028	2	R	word
lanMac	e.g., 00:90:E8:3E:18:CC -> 1st byte: 0, 2nd byte: 144, 3rd byte: 232, 4th byte: 62, 5th byte: 24, 6th byte: 204	5024	04: INPUT REGISTER	35025	3	R	word
modelName	Each byte represents ASCII code of each character	5000	04: INPUT REGISTER	35001	10	R	word
watchdogAlarmFlag	1: clear watchdog alarm	4144	01: COIL STATUS	04145	1	R/W	bit

ioLogik E1212 Modbus Address and Register Map

I/O

Parameter Name	Description	Start Address (decimal)	Point Type	Start Register (decimal)	Length	Access	Type
DI_counterOverflowFlag	0: Normal, 1: Overflow	1000	02: INPUT STATUS	11001	16	R	bit
DI_counterOverflowFlagClear	1: clear overflow flag	0288	01: COIL STATUS	00289	16	R/W	bit
DI_counterReset	1: reset to initial value	0272	01: COIL STATUS	00273	16	R/W	bit
DI_counterStatus	0: STOP, 1: START	0256	01: COIL STATUS	00257	16	R/W	bit
DI_counterValue	high/low word	0016	04: INPUT REGISTER	30017	32	R	2 words
DI_status	0: OFF, 1: ON	0000	02: INPUT STATUS	10001	16	R	bit
DI-all_statusFromDI-00	0: OFF, 1: ON	0048	04: INPUT REGISTER	30049	1	R	word
DO_p2pSafeModeFlagClear	1: clear safe mode flag	4128	01: COIL STATUS	04129	8	R/W	bit
DO_p2pSafeModeFlag	0: OFF, 1: ON	4112	02: INPUT STATUS	14113	8	R	bit
DO_p2pStatus	0: OFF, 1: ON	4096	02: INPUT STATUS	14097	8	R	bit
DO_pulseCount		0036	03: HOLDING REGISTER	40037	8	R/W	word
DO_pulseOffWidth	unit: 1 ms	0068	03: HOLDING REGISTER	40069	8	R/W	word
DO_pulseOnWidth	unit: 1 ms	0052	03: HOLDING REGISTER	40053	8	R/W	word
DO_pulseStatus	0: STOP, 1: START	0016	01: COIL STATUS	00017	8	R/W	bit
DO_status	0: OFF, 1: ON	0000	01: COIL STATUS	00001	8	R/W	bit
DO-all_statusFromDO-00	0: OFF, 1: ON	0032	03: HOLDING REGISTER	40033	1	R/W	word

System

Parameter Name	Description	Start Address (decimal)	Point Type	Start Register (decimal)	Length	Access	Type
deviceName	Each byte represents ASCII code of each character	5040	04: INPUT REGISTER	35041	30	R	word
deviceUpTime	unit: sec(s)	5020	04: INPUT REGISTER	35021	2	R	word
firmwareVersion	e.g., V1.2.3 -> 1st byte: 1, 2nd byte: 2, 3rd byte: 3	5029	04: INPUT REGISTER	35030	2	R	word
firmwareBuildDate	e.g., Build16051718 --> 16051718	5031	04: INPUT REGISTER	35032	2	R	word
lanIp	e.g., 192.168.127.254 -> 1st byte: 192, 2nd byte: 168, 3rd byte: 127, 4th byte: 254	5027	04: INPUT REGISTER	35028	2	R	word
lanMac	e.g., 00:90:E8:3E:18:CC -> 1st byte: 0, 2nd byte: 144, 3rd byte: 232, 4th byte: 62, 5th byte: 24, 6th byte: 204	5024	04: INPUT REGISTER	35025	3	R	word
modelName	Each byte represents ASCII code of each character	5000	04: INPUT REGISTER	35001	10	R	word
watchdogAlarmFlag	1: clear watchdog alarm	4144	01: COIL STATUS	04145	1	R/W	bit

ioLogik E1213 Modbus Address and Register Map

I/O

Parameter Name	Description	Start Address (decimal)	Point Type	Start Register (decimal)	Length	Access	Type
DI_counterOverflowFlag	0: Normal, 1: Overflow	1000	02:INPUT STATUS	11001	12	R	bit
DI_counterOverflowFlagClear	1: clear overflow flag	0288	01:COIL STATUS	00289	12	R/W	bit
DI_counterReset	1: reset to initial value	0272	01:COIL STATUS	00273	12	R/W	bit
DI_counterStatus	0: STOP, 1: START	0256	01:COIL STATUS	00257	12	R/W	bit
DI_counterValue	high/low word	0016	04:INPUT REGISTER	30017	24	R	2 words
DI_status	0: OFF, 1: ON	0000	02:INPUT STATUS	10001	12	R	bit
DI-all_statusFromDI-00	0: OFF, 1: ON	0048	04:INPUT REGISTER	30049	1	R	word
DO_p2pSafeModeFlagClear	1: clear safe mode flag	4128	01:COIL STATUS	04129	8	R/W	bit
DO_p2pSafeModeFlag	0: OFF, 1: ON	4112	02:INPUT STATUS	14113	8	R	bit
DO_p2pStatus	0: OFF, 1: ON	4096	02:INPUT STATUS	14097	8	R	bit
DO_pulseCount		0036	03:HOLDING REGISTER	40037	8	R/W	word
DO_pulseOffWidth	unit: 1 ms	0068	03:HOLDING REGISTER	40069	8	R/W	word
DO_pulseOnWidth	unit: 1 ms	0052	03:HOLDING REGISTER	40053	8	R/W	word
DO_pulseStatus	0: STOP, 1: START	0016	01:COIL STATUS	00017	8	R/W	bit
DO_status	0: OFF, 1: ON	0000	01:COIL STATUS	00001	8	R/W	bit
DO-all_statusFromDO-00	0: OFF, 1: ON	0032	03:HOLDING REGISTER	40033	1	R/W	word

System

Parameter Name	Description	Start Address (decimal)	Point Type	Start Register (decimal)	Length	Access	Type
deviceName	Each byte represents ASCII code of each character	5040	04:INPUT REGISTER	35041	30	R	word
deviceUpTime	unit: sec(s)	5020	04:INPUT REGISTER	35021	2	R	word
firmwareVersion	e.g., V1.2.3 -> 1st byte: 1, 2nd byte: 2, 3rd byte: 3	5029	04:INPUT REGISTER	35030	2	R	word
firmwareBuildDate	e.g., Build16051718 --> 16051718	5031	04:INPUT REGISTER	35032	2	R	word
lanIp	e.g., 192.168.127.254 -> 1st byte: 192, 2nd byte: 168, 3rd byte: 127, 4th byte: 254	5027	04:INPUT REGISTER	35028	2	R	word
lanMac	e.g., 00:90:E8:3E:18:CC -> 1st byte: 0, 2nd byte: 144, 3rd byte: 232, 4th byte: 62, 5th byte: 24, 6th byte: 204	5024	04:INPUT REGISTER	35025	3	R	word
modelName	Each byte represents ASCII code of each character	5000	04:INPUT REGISTER	35001	10	R	word
watchdogAlarmFlag	1: clear watchdog alarm	4144	01:COIL STATUS	04145	1	R/W	bit

ioLogik E1214 Modbus Address and Register Map

I/O

Parameter Name	Description	Start Address (decimal)	Point Type	Start Register (decimal)	Length	Access	Type
DI_counterOverflowFlag	0: Normal, 1: Overflow	1000	02:INPUT STATUS	11001	6	R	bit
DI_counterOverflowFlagClear	1: clear overflow flag	0288	01:COIL STATUS	00289	6	R/W	bit
DI_counterReset	1: reset to initial value	0272	01:COIL STATUS	00273	6	R/W	bit
DI_counterStatus	0: STOP, 1: START	0256	01:COIL STATUS	00257	6	R/W	bit
DI_counterValue	high/low word	0016	04:INPUT REGISTER	30017	12	R	2 words
DI_status	0: OFF, 1: ON	0000	02:INPUT STATUS	10001	6	R	bit
DI-all_statusFromDI-00	0: OFF, 1: ON	0048	04:INPUT REGISTER	30049	1	R	word
RLY_currentCount	high/low word	0096	04:INPUT REGISTER	30097	12	R	2 words
RLY_currentCountReset	1: reset current count	0048	01:COIL STATUS	00048	6	R/W	bit
RLY_p2pSafeModeFlagClear	1: clear safe mode flag	4128	01:COIL STATUS	04129	6	R/W	bit
RLY_p2pSafeModeFlag	0: OFF, 1: ON	4112	02:INPUT STATUS	14113	6	R	bit
RLY_p2pStatus	0: OFF, 1: ON	4096	02:INPUT STATUS	14097	6	R	bit
RLY_pulseCount	high/low word	0036	03:HOLDING REGISTER	40037	12	R/W	2 words
RLY_pulseOffWidth	unit: 1.5 sec	0068	03:HOLDING REGISTER	40069	6	R/W	word
RLY_pulseOnWidth	unit: 1.5 sec	0052	03:HOLDING REGISTER	40053	6	R/W	word
RLY_pulseStatus	0: STOP, 1: START	0016	01:COIL STATUS	00017	6	R/W	bit
RLY_status	0: OFF, 1: ON	0000	01:COIL STATUS	00001	6	R/W	bit
RLY_TotalCount	high/low word	0064	04:INPUT REGISTER	30065	12	R	2 words
RLY-all_statusFromRLY-00	0: OFF, 1: ON	0032	03:HOLDING REGISTER	40033	1	R/W	word

System

Parameter Name	Description	Start Address (decimal)	Point Type	Start Register (decimal)	Length	Access	Type
deviceName	Each byte represents ASCII code of each character	5040	04:INPUT REGISTER	35041	30	R	word
deviceUpTime	unit: sec(s)	5020	04:INPUT REGISTER	35021	2	R	word
firmwareVersion	e.g., V1.2.3 -> 1st byte: 1, 2nd byte: 2, 3rd byte: 3	5029	04:INPUT REGISTER	35030	2	R	word
firmwareBuildDate	e.g., Build16051718 --> 16051718	5031	04:INPUT REGISTER	35032	2	R	word
lanIp	e.g., 192.168.127.254 -> 1st byte: 192, 2nd byte: 168, 3rd byte: 127, 4th byte: 254	5027	04:INPUT REGISTER	35028	2	R	word
lanMac	e.g., 00:90:E8:3E:18:CC -> 1st byte: 0, 2nd byte: 144, 3rd byte: 232, 4th byte: 62, 5th byte: 24, 6th byte: 204	5024	04:INPUT REGISTER	35025	3	R	word
modelName	Each byte represents ASCII code of each character	5000	04:INPUT REGISTER	35001	10	R	word
watchdogAlarmFlag	1: clear watchdog alarm	4144	01:COIL STATUS	04145	1	R/W	bit

ioLogik E1240 Modbus Address and Register Map

I/O

Parameter Name	Description	Start Address (decimal)	Point Type	Start Register (decimal)	Length	Access	Type
AI_burnoutValue	high/low word	0040	03:HOLDING REGISTER	40041	16	R/W	2 words
AI_mode	0: 0-10 V 1: 4-20mA 2: 0-20mA 4: 4-20mA burnout	0024	03:HOLDING REGISTER	40025	8	R/W	word
AI_rawValue		0000	04:INPUT REGISTER	30001	8	R	word
AI_rawValueMax		0032	04:INPUT REGISTER	30033	8	R	word
AI_rawValueMin		0024	04:INPUT REGISTER	30025	8	R	word
AI_resetMaxValue	1: reset max. value	4153	01:COIL STATUS	04154	8	R/W	bit
AI_resetMinValue	1: reset min. value	4145	01:COIL STATUS	04146	8	R/W	bit
AI_scaledValue	high/low word	0008	04:INPUT REGISTER	30009	16	R	2 words
AI_scaledValueMax	high/low word	0125	04:INPUT REGISTER	30126	16	R	2 words
AI_scaledValueMin	high/low word	0109	04:INPUT REGISTER	30110	16	R	2 words
AI_status	0: normal, 1: burnout, 2: over range, 3: under range	0060	04:INPUT REGISTER	30061	8	R	word

System

Parameter Name	Description	Start Address (decimal)	Point Type	Start Register (decimal)	Length	Access	Type
deviceName	Each byte represents ASCII code of each character	5040	04:INPUT REGISTER	35041	30	R	word
deviceUpTime	unit: sec(s)	5020	04:INPUT REGISTER	35021	2	R	word
firmwareVersion	e.g., V1.2.3 -> 1st byte: 1, 2nd byte: 2, 3rd byte: 3	5029	04:INPUT REGISTER	35030	2	R	word
firmwareBuildDate	e.g., Build16051718 --> 16051718	5031	04:INPUT REGISTER	35032	2	R	word
lanIp	e.g., 192.168.127.254 -> 1st byte: 192, 2nd byte: 168, 3rd byte: 127, 4th byte: 254	5027	04:INPUT REGISTER	35028	2	R	word
lanMac	e.g., 00:90:E8:3E:18:CC -> 1st byte: 0, 2nd byte: 144, 3rd byte: 232, 4th byte: 62, 5th byte: 24, 6th byte: 204	5024	04:INPUT REGISTER	35025	3	R	word
modelName	Each byte represents ASCII code of each character	5000	04:INPUT REGISTER	35001	10	R	word

ioLogik E1241 Modbus Address and Register Map

I/O

Parameter Name	Description	Start Address (decimal)	Point Type	Start Register (decimal)	Length	Access	Type
AO_p2pSafeModeFlag Clear	1: clear safe mode flag	4128	01:COIL STATUS	04129	4	R/W	bit
AO_p2pSafeModeFlag	0: OFF, 1: ON	4112	02:INPUT STATUS	14113	4	R	bit
AO_p2pStatus	0: OFF, 1: ON	4096	02:INPUT STATUS	14097	4	R	bit
AO_rawValue		1024	03: HOLDING REGISTER	41025	4	R/W	word
AO_scaledValue	high/low word	0000	03: HOLDING REGISTER	40001	8	R/W	2 words

System

Parameter Name	Description	Start Address (decimal)	Point Type	Start Register (decimal)	Length	Access	Type
deviceName	Each byte represents ASCII code of each character	5040	04:INPUT REGISTER	35041	30	R	word
deviceUpTime	unit: sec(s)	5020	04:INPUT REGISTER	35021	2	R	word
firmwareVersion	e.g., V1.2.3 -> 1st byte: 1, 2nd byte: 2, 3rd byte: 3	5029	04:INPUT REGISTER	35030	2	R	word
firmwareBuildDate	e.g., Build16051718 --> 16051718	5031	04:INPUT REGISTER	35032	2	R	word
lanIp	e.g., 192.168.127.254 -> 1st byte: 192, 2nd byte: 168, 3rd byte: 127, 4th byte: 254	5027	04:INPUT REGISTER	35028	2	R	word
lanMac	e.g., 00:90:E8:3E:18:CC -> 1st byte: 0, 2nd byte: 144, 3rd byte: 232, 4th byte: 62, 5th byte: 24, 6th byte: 204	5024	04:INPUT REGISTER	35025	3	R	word
modelName	Each byte represents ASCII code of each character	5000	04:INPUT REGISTER	35001	10	R	word
watchdogAlarmFlag	1: clear watchdog alarm	4144	01:COIL STATUS	04145	1	R/W	bit

ioLogik E1242 Modbus Address and Register Map



NOTE

1. AI_scaledValue incorporates word swapping.
2. DI_counterValue incorporates byte swapping.

I/O

Parameter Name	Description	Start Address (decimal)	Point Type	Start Register (decimal)	Length	Access	Type
AI_burnoutValue	high/low word	0560	03:HOLDING REGISTER	40561	8	R/W	2 words
AI_mode	0: 0-10 V 1: 4-20mA 2: 0-20mA 4: 4-20mA burnout	0544	03:HOLDING REGISTER	40545	4	R/W	word
AI_rawValue		0512	04:INPUT REGISTER	30513	4	R	word
AI_rawValueMax		0532	04:INPUT REGISTER	30533	4	R	word
AI_rawValueMin		0528	04:INPUT REGISTER	30529	4	R	word
AI_resetMaxValue	1: reset max. value	4153	01:COIL STATUS	04154	4	R/W	bit
AI_resetMinValue	1: reset min. value	4145	01:COIL STATUS	04146	4	R/W	bit
AI_scaledValue	high/low word	0520	04:INPUT REGISTER	30521	8	R	2 words
AI_scaledValueMax	high/low word	0546	04:INPUT REGISTER	30547	8	R	2 words
AI_scaledValueMin	high/low word	0536	04:INPUT REGISTER	30537	8	R	2 words
AI_status	0: normal, 1: burnout, 2: over range, 3: under range	0576	04:INPUT REGISTER	30577	4	R	word
DI_counterOverflowFlag	0: Normal, 1: Overflow	1000	02:INPUT STATUS	11001	8	R	bit
DI_counterOverflowFlagClear	1: clear overflow flag	0288	01:COIL STATUS	00289	8	R/W	bit
DI_counterReset	1: reset to initial value	0272	01:COIL STATUS	00273	8	R/W	bit
DI_counterStatus	0: STOP, 1: START	0256	01:COIL STATUS	00257	8	R/W	bit
DI_counterValue	high/low word	0016	04:INPUT REGISTER	30017	16	R	2 words
DI_status	0: OFF, 1: ON	0000	02:INPUT STATUS	10001	8	R	bit
DI-all_statusFromDI-00	0: OFF, 1: ON	0048	04:INPUT REGISTER	30049	1	R	word
DO_p2pSafeModeFlagClear	1: clear safe mode flag	4128	01:COIL STATUS	04129	4	R/W	bit
DO_p2pSafeModeFlag	0: OFF, 1: ON	4112	02:INPUT STATUS	14113	4	R	bit

Parameter Name	Description	Start Address (decimal)	Point Type	Start Register (decimal)	Length	Access	Type
DO_p2pStatus	0: OFF, 1: ON	4096	02:INPUT STATUS	14097	4	R	bit
DO_pulseCount		0036	03:HOLDING REGISTER	40037	4	R/W	word
DO_pulseOffWidth	unit: 1 ms	0068	03:HOLDING REGISTER	40069	4	R/W	word
DO_pulseOnWidth	unit: 1 ms	0052	03:HOLDING REGISTER	40053	4	R/W	word
DO_pulseStatus	0: STOP, 1: START	0016	01:COIL STATUS	00017	4	R/W	bit
DO_status	0: OFF, 1: ON	0000	01:COIL STATUS	00001	4	R/W	bit
DO-all_statusFromDO-00	0: OFF, 1: ON	0032	03:HOLDING REGISTER	40033	1	R/W	word

System

Parameter Name	Description	Start Address (decimal)	Point Type	Start Register (decimal)	Length	Access	Type
deviceName	Each byte represents ASCII code of each character	5040	04:INPUT REGISTER	35041	30	R	word
deviceUpTime	unit: sec(s)	5020	04:INPUT REGISTER	35021	2	R	word
firmwareVersion	e.g., V1.2.3 -> 1st byte: 1, 2nd byte: 2, 3rd byte: 3	5029	04:INPUT REGISTER	35030	2	R	word
firmwareBuildDate	e.g., Build16051718 --> 16051718	5031	04:INPUT REGISTER	35032	2	R	word
lanIp	e.g., 192.168.127.254 -> 1st byte: 192, 2nd byte: 168, 3rd byte: 127, 4th byte: 254	5027	04:INPUT REGISTER	35028	2	R	word
lanMac	e.g., 00:90:E8:3E:18:CC -> 1st byte: 0, 2nd byte: 144, 3rd byte: 232, 4th byte: 62, 5th byte: 24, 6th byte: 204	5024	04:INPUT REGISTER	35025	3	R	word
modelName	Each byte represents ASCII code of each character	5000	04:INPUT REGISTER	35001	10	R	word

Parameter Name	Description	Start Address (decimal)	Point Type	Start Register (decimal)	Length	Access	Type
watchdogAlarmFlag	1: clear watchdog alarm	4144	01:COIL STATUS	04145	1	R/W	bit

ioLogik E1260 Modbus Address and Register Map

I/O

Parameter Name	Description	Start Address (decimal)	Point Type	Start Register (decimal)	Length	Access	Type
RTD_multipliedEngineeringValue	Unit: 0.1	1536	04:INPUT REGISTER	31537	6	R	word
RTD_multipliedEngineeringValueMax	high/low word	1572	04:INPUT REGISTER	31573	6	R	word
RTD_multipliedEngineeringValueMin	high/low word	1560	04:INPUT REGISTER	31561	6	R	word
RTD_resetMaxValue	1: reset max. value	4169	01:COIL STATUS	04170	6	R/W	bit
RTD_resetMinValue	1: reset min. value	4161	01:COIL STATUS	04162	6	R/W	bit
RTD_scaledValue	high/low word	1548	04:INPUT REGISTER	31549	12	R	2 words
RTD_scaledValueMax	high/low word	1596	04:INPUT REGISTER	31597	12	R	2 words
RTD_scaledValueMin	high/low word	1584	04:INPUT REGISTER	31585	12	R	2 words

System

Parameter Name	Description	Start Address (decimal)	Point Type	Start Register (decimal)	Length	Access	Type
deviceName	Each byte represents ASCII code of each character	5040	04:INPUT REGISTER	35041	30	R	word
deviceUpTime	unit: sec(s)	5020	04:INPUT REGISTER	35021	2	R	word
firmwareVersion	e.g., V1.2.3 -> 1st byte: 1, 2nd byte: 2, 3rd byte: 3	5029	04:INPUT REGISTER	35030	2	R	word
firmwareBuildDate	e.g., Build16051718 --> 16051718	5031	04:INPUT REGISTER	35032	2	R	word
lanIp	e.g., 192.168.127.254 -> 1st byte: 192, 2nd byte: 168, 3rd byte: 127, 4th byte: 254	5027	04:INPUT REGISTER	35028	2	R	word

Parameter Name	Description	Start Address (decimal)	Point Type	Start Register (decimal)	Length	Access	Type
IanMac	e.g., 00:90:E8:3E:18:CC -> 1st byte: 0, 2nd byte: 144, 3rd byte: 232, 4th byte: 62, 5th byte: 24, 6th byte: 204	5024	04:INPUT REGISTER	35025	3	R	word
modelName	Each byte represents ASCII code of each character	5000	04:INPUT REGISTER	35001	10	R	word

ioLogik E1262 Modbus Address and Register Map

I/O

Parameter Name	Description	Start Address (decimal)	Point Type	Start Register (decimal)	Length	Access	Type
TC_CJC	TC CJC calibration start	4193	01:COIL STATUS	04194	8	R/W	bit
TC_refEngValue (float)	TC calibration reference	2144	03:HOLDING REGISTER	42145	8	R/W	2 words
TC_multipliedEngineeringValue	high/low word, Unit:0.1 (Celsius, Fahrenheit) or 0.0001 (mV)	2048	04:INPUT REGISTER	32049	16	R	2 words
TC_multipliedEngineeringValueMax	high/low word, Unit:0.1 (Celsius, Fahrenheit) or 0.0001 (mV)	2096	04:INPUT REGISTER	32097	16	R	2 words
TC_multipliedEngineeringValueMin	high/low word, Unit:0.1 (Celsius, Fahrenheit) or 0.0001 (mV)	2080	04:INPUT REGISTER	32081	16	R	2 words
TC_resetMaxValue	1: reset max. value	4185	01:COIL STATUS	04186	8	R/W	bit
TC_resetMinValue	1: reset min. value	4177	01:COIL STATUS	04178	8	R/W	bit
TC_scaledValue	high/low word	2064	04:INPUT REGISTER	32065	16	R	2 words
TC_scaledValueMax	high/low word	2128	04:INPUT REGISTER	32129	16	R	2 words
TC_scaledValueMin	high/low word	2112	04:INPUT REGISTER	32113	16	R	2 words

System

Parameter Name	Description	Start Address (decimal)	Point Type	Start Register (decimal)	Length	Access	Type
deviceName	Each byte represents ASCII code of each character	5040	04:INPUT REGISTER	35041	30	R	word
deviceUpTime	unit: sec(s)	5020	04:INPUT REGISTER	35021	2	R	word
firmwareVersion	e.g., V1.2.3 -> 1st byte: 1, 2nd byte: 2, 3rd byte: 3	5029	04:INPUT REGISTER	35030	2	R	word
firmwareBuildDate	e.g., Build16051718 --> 16051718	5031	04:INPUT REGISTER	35032	2	R	word
lanIp	e.g., 192.168.127.254 -> 1st byte: 192, 2nd byte: 168, 3rd byte: 127, 4th byte: 254	5027	04:INPUT REGISTER	35028	2	R	word
lanMac	e.g., 00:90:E8:3E:18:CC -> 1st byte: 0, 2nd byte: 144, 3rd byte: 232, 4th byte: 62, 5th byte: 24, 6th byte: 204	5024	04:INPUT REGISTER	35025	3	R	word
modelName	Each byte represents ASCII code of each character	5000	03:HOLDING REGISTER	40001	10	R/W	word

B. EtherNet/IP Default Address Mappings

ioLogik E1200 EtherNet/IP Map

Supported Service

Service Code	Class Level	Instance Level	Service Name	Description
0x05	No	Yes	Reset	Restart device
0x0E	Yes	Yes	Get_Attribute_Single	Read an attribute
0x10	No	Yes	Set_Attribute_Single	Modify an attribute

Assembly Object (0x04)

Instance	Attribute ID	Access	Name	Data Type	Description
0x00	0x01	GET	Revision	UINT	Revision of this object
0x65	0x03	GET	Input Data	ARRAY of BYTE	Data Map by Models
0x65	0x04	GET	Size	UINT	Number of BYTE in attribute 0x03
0x66	0x03	SET	Output Data	ARRAY of BYTE	Data Map by Models
0x66	0x04	GET	Size	UINT	Number of BYTE in attribute 0x03

Input Data Map by Models

Model	Channels	BYTE #	Access	Name	Data Type	Description
ioLogik E1210	DI-15...00	1...0	GET	diStatus	BOOL	DI - DI mode - status (0: OFF, 1: ON)
		65...2	GET	diCounterValue	UDINT	DI - Counter mode - value
ioLogik E1211	DO-15...00	1...0	GET	doStatus	BOOL	DO - DO mode - status (0: OFF, 1: ON)
ioLogik E1212	DI-15...00	1...0	GET	diStatus	BOOL	DI - DI mode - status (0: OFF, 1: ON)
		65...2	GET	diCounterValue	UDINT	DI - Counter mode - value
	DO-07...00	66	GET	doStatus	BOOL	DO - DO mode - status (0: OFF, 1: ON)
ioLogik E1213	DI-11...00	1...0	GET	diStatus	BOOL	DI - DI mode - status (0: OFF, 1: ON)
		49...2	GET	diCounterValue	UDINT	DI - Counter mode - value
	DO-07...00	50	GET	doStatus	BOOL	DO - DO mode - status (0: OFF, 1: ON)
ioLogik E1214	DI-05...00	0	GET	diStatus	BOOL	DI - DI mode - status (0: OFF, 1: ON)
		24...1	GET	diCounterValue	UDINT	DI - Counter mode - value
	RLY-05...00	25	GET	relayStatus	BOOL	Relay - Relay mode - status (0: OFF, 1: ON)
ioLogik E1240	AI-07...00	15...0	GET	aiValueRaw	UINT	AI - raw value
ioLogik E1241	AO-03...00	7...0	GET	aoValueRaw	UINT	AO - raw value
ioLogik E1242	DI-07...00	0	GET	diStatus	BOOL	DI - DI mode - status (0: OFF, 1: ON)
		32...1	GET	diCounterValue	UDINT	DI - Counter mode - value
	DO-03...00	33	GET	doStatus	BOOL	DO - DO mode - status (0: OFF, 1: ON)
	AI-03...00	41...34	GET	aiValueRaw	UINT	AI - raw value
ioLogik E1260	RTD-05...00	11...0	GET	rtdValueEngineeringMultiplied	UINT	RTD - Engineering Multiplied value
ioLogik E1262	TC-07...00	31...0	GET	tcValueEngineeringMultiplied	UDINT	TC - Engineering Multiplied value

Output Data Map by Models

Model	Channels	BYTE #	Access	Name	Data Type	Description
ioLogik E1211	DO-15...00	1...0	SET	doStatus	BOOL	DO - DO mode - status (0: OFF, 1: ON)
ioLogik E1212	DO-07...00	0	SET	doStatus	BOOL	DO - DO mode - status (0: OFF, 1: ON)
ioLogik E1213	DO-07...00	0	SET	doStatus	BOOL	DO - DO mode - status (0: OFF, 1: ON)
ioLogik E1214	RLY-05...00	0	SET	relayStatus	BOOL	Relay - Relay mode - status (0: OFF, 1: ON)
ioLogik E1241	AO-03...00	7...0	SET	aoValueRaw	UINT	AO - raw value
ioLogik E1242	DO-03...00	0	SET	doStatus	BOOL	DO - DO mode - status (0: OFF, 1: ON)

DI Channel Object (0x65)

Instance	Attribute ID	Access	Name	Data Type	Description
0x00	0x01	GET	Revision	UINT	class revision
0x64	0x01	GET	diIndex	UINT	DI - index
0x64	0x02	GET	diMode	BOOL	DI - mode (0: DI, 1: Counter)
0x64	0x03	GET	diStatus	BOOL	DI - DI mode - status (0: OFF, 1: ON)
0x64	0x04	GET	diCounterValue	UDINT	DI - Counter mode - value
0x64	0x05	SET	diCounterStatus	BOOL	DI - Counter mode - status (0: STOP, 1: START)
0x64	0x06	SET	diCounterReset	BOOL	DI - Counter mode - reset to initial value (1: RESET)
0x64	0x07	GET	diCounterOverflowFlag	BOOL	DI - Counter mode - overflow flag (0: Normal, 1: Overflow)
0x64	0x11	SET	diCounterOverflowFlag Clear	BOOL	DI - Counter mode - clear overflow flag (1: Clear)

DO Channel Object (0x67)

Instance	Attribute ID	Access	Name	Data Type	Description
0x00	0x01	GET	Revision	UINT	class revision
0x64	0x01	GET	doIndex	UINT	DO - index
0x64	0x02	GET	doMode	BOOL	DO - mode (0: DO, 1: Pulse)
0x64	0x03	SET	doStatus	BOOL	DO - DO mode - status (0: OFF, 1: ON)
0x64	0x04	SET	doPulseStatus	BOOL	DO - Pulse mode - status (0: STOP, 1: START)
0x64	0x05	SET	doPulseCount	UINT	DO - Pulse mode - count
0x64	0x06	SET	doPulseOnWidth	UINT	DO - Pulse mode - ON width (unit: 1 ms)
0x64	0x07	SET	doPulseOffWidth	UINT	DO - Pulse mode - OFF width (unit: 1 ms)

Relay Channel Object (0x6A)

Instance	Attribute ID	Access	Name	Data Type	Description
0x00	0x01	GET	Revision	UINT	class revision
0x64	0x01	GET	relayIndex	UINT	Relay - index
0x64	0x02	GET	relayMode	BOOL	Relay - mode (0: Relay, 1: Pulse)
0x64	0x03	SET	relayStatus	BOOL	Relay - Relay mode - status (0: OFF, 1: ON)
0x64	0x04	SET	relayPulseStatus	BOOL	Relay - Pulse mode - status (0: STOP, 1: START)
0x64	0x05	SET	relayPulseCount	UINT	Relay - Pulse mode - count
0x64	0x06	SET	relayPulseOnWidth	UINT	Relay - Pulse mode - ON width (unit: 1.5 s)
0x64	0x07	SET	relayPulseOffWidth	UINT	Relay - Pulse mode - OFF width (unit: 1.5 s)
0x64	0x08	GET	relayTotalCount	UDINT	Relay - Relay mode - total count
0x64	0x09	GET	relayCurrentCount	UDINT	Relay - Relay mode - current count
0x64	0x0A	SET	relayCurrentCountReset	BOOL	Relay - Relay mode - reset current count (1: RESET)

AI Channel Object (0x6B)

Instance	Attribute ID	Access	Name	Data Type	Description
0x00	0x01	GET	Revision	UINT	class revision
0x64	0x01	GET	aiIndex	UINT	AI - index
0x64	0x02	GET	aiMode	UINT	AI - mode (0: 0-10 V, 1: 4-20 mA, 2: 0-20 mA, 4: 4-20 mA burnout)
0x64	0x03	GET	aiValueRaw	UINT	AI - raw value
0x64	0x04	GET	aiValueScaled	REAL	AI - scaled value
0x64	0x05	GET	aiValueRawMin	UINT	AI - minimum raw value
0x64	0x06	GET	aiValueRawMax	UINT	AI - maximum raw value
0x64	0x07	GET	aiValueScaledMin	REAL	AI - minimum scaled value
0x64	0x08	GET	aiValueScaledMax	REAL	AI - maximum scaled value
0x64	0x09	SET	aiResetMinValue	BOOL	AI - reset minimum value (1: RESET)
0x64	0x0A	SET	aiResetMaxValue	BOOL	AI - reset maximum value (1: RESET)
0x64	0x0B	GET	aiStatus	UINT	AI - status (0: normal, 1: burnout, 2: over range, 3: under range)
0x64	0x0C	GET	aiBurnoutValue	REAL	AI - burnout value

AO Channel Object (0x6C)

Instance	Attribute ID	Access	Name	Data Type	Description
0x00	0x01	GET	Revision	UINT	class revision
0x64	0x01	GET	aoIndex	UINT	AO - index
0x64	0x02	GET	aoMode	UINT	AO - mode (0: 0-10 V, 1: 4-20 mA, 2: 0-20 mA)
0x64	0x03	SET	aoValueRaw	UINT	AO - raw value
0x64	0x04	GET	aoValueScaled	REAL	AO - scaled value

RTD Channel Object (0x6D)

Instance	Attribute ID	Access	Name	Data Type	Description
0x00	0x01	GET	Revision	UINT	class revision
0x64	0x01	GET	rtdIndex	UINT	RTD - index
0x64	0x02	GET	rtdSensorType	UINT	RTD - sensor type
0x64	0x03	GET	rtdValueEngineering Multiplied	UINT	RTD - Engineering Multiplied value
0x64	0x04	GET	rtdValueScaled	REAL	RTD - scaled value
0x64	0x05	GET	rtdValueEngineering MultipliedMin	UINT	RTD - minimum Engineering Multiplied value
0x64	0x06	GET	rtdValueEngineering MultipliedMax	UINT	RTD - maximum Engineering Multiplied value
0x64	0x07	GET	rtdValueScaledMin	REAL	RTD - minimum scaled value
0x64	0x08	GET	rtdValueScaledMax	REAL	RTD - maximum scaled value
0x64	0x09	SET	rtdResetMinValue	BOOL	RTD - reset minimum value (1: RESET)
0x64	0x0A	SET	rtdResetMaxValue	BOOL	RTD - reset maximum value (1: RESET)

TC Channel Object (0x6E)

Instance	Attribute ID	Access	Name	Data Type	Description
0x00	0x01	GET	Revision	UINT	class revision
0x64	0x01	GET	tcIndex	UINT	TC - index
0x64	0x02	GET	tcSensorType	UINT	TC - sensor type
0x64	0x03	GET	tcValueEngineering Multiplied	UDINT	TC - Engineering Multiplied value
0x64	0x04	GET	tcValueScaled	REAL	TC - scaled value
0x64	0x05	GET	tcValueEngineering MultipliedMin	UDINT	TC - minimum Engineering Multiplied value
0x64	0x06	GET	tcValueEngineering MultipliedMax	UDINT	TC - maximum Engineering Multiplied value
0x64	0x07	GET	tcValueScaledMin	REAL	TC - minimum scaled value
0x64	0x08	GET	tcValueScaledMax	REAL	TC - maximum scaled value
0x64	0x09	SET	tcResetMinValue	BOOL	TC - reset minimum value (1: RESET)
0x64	0x0A	SET	tcResetMaxValue	BOOL	TC - reset maximum value (1: RESET)

C. RESTful API Default Address Mappings

ioLogik E1200 RESTful API Map

The operating parameters of http should be specified in the header.

- Accept: vdn.dac.v1
- Content-Type: application/json

Supported Methods

- GET
- PUT
- OPTIONS



NOTE

The OPTIONS method is used to describe the communication options for the target resource.

API List

RESTful API	Name	Description	Access
/api/slot/0/sysInfo			
/api/slot/0/sysInfo/device	modelName	model name	read-only
/api/slot/0/sysInfo/device	deviceName	device name	read-only
/api/slot/0/sysInfo/device	deviceUpTime	device up time	read-only
/api/slot/0/sysInfo/device	firmwareVersion	firmware version	read-only
/api/slot/0/sysInfo/network			
/api/slot/0/sysInfo/network/LAN			
/api/slot/0/sysInfo/network/LAN	lanMac	MAC address	read-only
/api/slot/0/sysInfo/network/LAN	lanIp	IP address	read-only
/api/slot/0/io/di			
/api/slot/0/io/di	diIndex	DI - index	read-only
/api/slot/0/io/di	diMode	DI - mode (0: DI, 1: Counter)	read-only
/api/slot/0/io/di	diStatus	DI - DI mode - status (0: OFF, 1: ON)	read-only
/api/slot/0/io/di	diCounterValue	DI - Counter mode - value	read-only
/api/slot/0/io/di	diCounterReset	DI - Counter mode - reset to initial value (1: RESET)	read-write
/api/slot/0/io/di	diCounterOverflowFlag	DI - Counter mode - overflow flag (0: Normal, 1: Overflow)	read-only
/api/slot/0/io/di	diCounterOverflowClear	DI - Counter mode - clear overflow flag (1: Clear)	read-write
/api/slot/0/io/di	diCounterStatus	DI - Counter mode - status (0: STOP, 1: START)	read-write
/api/slot/0/io/di/0/diStatus	diStatus	DI - DI mode - status (0: OFF, 1: ON)	read-only
/api/slot/0/io/di/0/diCounterValue	diCounterValue	DI - Counter mode - value	read-only
/api/slot/0/io/di/0/diCounterReset		DI - Counter mode - reset to initial value (1: RESET)	read-write
/api/slot/0/io/di/0/diCounterStatus		DI - Counter mode - status (0: STOP, 1: START)	read-write
/api/slot/0/io/do			

RESTful API	Name	Description	Access
/api/slot/0/io/do	doIndex	DO - index	read-only
/api/slot/0/io/do	doMode	DO - mode (0: DO, 1: Pulse)	read-only
/api/slot/0/io/do	doStatus	DO - DO mode - status (0: OFF, 1: ON)	read-write
/api/slot/0/io/do	doPulseCount	DO - Pulse mode - count	read-write
/api/slot/0/io/do	doPulseOnWidth	DO - Pulse mode - ON width (unit: 1 ms)	read-write
/api/slot/0/io/do	doPulseOffWidth	DO - Pulse mode - OFF width (unit: 1 ms)	read-write
/api/slot/0/io/do	doPulseStatus	DO - Pulse mode - status (0: STOP, 1: START)	read-write
/api/slot/0/io/do/0/doStatus	doStatus	DO - DO mode - status (0: OFF, 1: ON)	read-write
/api/slot/0/io/do/0/doPulseCount	doPulseCount	DO - Pulse mode - count	read-write
/api/slot/0/io/do/0/doPulseStatus	doPulseStatus	DO - Pulse mode - status (0: STOP, 1: START)	read-write
/api/slot/0/io/relay	relayIndex	Relay - index	read-only
/api/slot/0/io/relay			
/api/slot/0/io/relay	relayMode	Relay - mode (0: Relay, 1: Pulse)	read-only
/api/slot/0/io/relay	relayStatus	Relay - Relay mode - status (0: OFF, 1: ON)	read-write
/api/slot/0/io/relay	relayTotalCount	Relay - Relay mode - total count	read-only
/api/slot/0/io/relay	relayCurrentCount	Relay - Relay mode - current count	read-only
/api/slot/0/io/relay	relayCurrentCountReset	Relay - Relay mode - reset current count (1: RESET)	read-write
/api/slot/0/io/relay	relayPulseStatus	Relay - Pulse mode - status (0: STOP, 1: START)	read-write
/api/slot/0/io/relay	relayPulseCount	Relay - Pulse mode - count	read-write
/api/slot/0/io/relay	relayPulseOnWidth	Relay - Pulse mode - ON width (unit: 1.5 s)	read-write
/api/slot/0/io/relay	relayPulseOffWidth	Relay - Pulse mode - OFF width (unit: 1.5 s)	read-write
/api/slot/0/io/relay/0/relayStatus	relayStatus	Relay - Relay mode - status (0: OFF, 1: ON)	read-write
/api/slot/0/io/relay/0/relayPulseStatus	relayPulseStatus	Relay - Pulse mode - status (0: STOP, 1: START)	read-write
/api/slot/0/io/relay/0/relayPulseCount	relayPulseCount	Relay - Pulse mode - count	read-write
/api/slot/0/io/ai			
/api/slot/0/io/ai	aiIndex	AI - index	read-only
/api/slot/0/io/ai	aiMode	AI - mode (0: 0-10 V, 1: 4-20mA, 2: 0-20mA, 4: 4-20mA burnout)	read-only
/api/slot/0/io/ai	aiValueRaw	AI - raw value	read-only
/api/slot/0/io/ai	aiValueScaled	AI - scaled value	read-only
/api/slot/0/io/ai	aiValueRawMin	AI - minimum raw value	read-only
/api/slot/0/io/ai	aiValueRawMax	AI - maximum raw value	read-only
/api/slot/0/io/ai	aiValueScaledMin	AI - minimum scaled value	read-only
/api/slot/0/io/ai	aiValueScaledMax	AI - maximum scaled value	read-only
/api/slot/0/io/ai	aiResetMinValue	AI - reset minimum value (1: RESET)	read-write
/api/slot/0/io/ai	aiResetMaxValue	AI - reset maximum value (1: RESET)	read-write
/api/slot/0/io/ai	aiStatus	AI - status (0: normal, 1: burnout, 2: over range, 3. under range)	read-only

RESTful API	Name	Description	Access
/api/slot/0/io/ai	aiBurnoutValue	AI - burnout value	read-only
/api/slot/0/io/ai/0/aiValueRaw	aiValueRaw	AI - raw value	read-only
/api/slot/0/io/ao			
/api/slot/0/io/ao	aoIndex	AO - index	read-only
/api/slot/0/io/ao	aoMode	AO - mode (0: 0-10 V, 1: 4-20mA, 2: 0-20 mA)	read-only
/api/slot/0/io/ao	aoValueRaw	AO - raw value	read-write
/api/slot/0/io/ao	aoValueScaled	AO - scaled value	read-only
/api/slot/0/io/ao/0/aoValueRaw	aoValueRaw	AO - raw value	read-write
/api/slot/0/io/ao/0/aoValueScaled	aoValueScaled	AO - scaled value	read-write
/api/slot/0/io/rtd			
/api/slot/0/io/rtd	rtdIndex	RTD - index	read-only
/api/slot/0/io/rtd	rtdSensorType	RTD - sensor type	read-only
/api/slot/0/io/rtd	rtdValueEngineeringMultiplied	RTD - engineering multiplied value	read-only
/api/slot/0/io/rtd	rtdValueEngineeringMultipliedMin	RTD - engineering multiplied minimum value	read-only
/api/slot/0/io/rtd	rtdValueEngineeringMultipliedMax	RTD - engineering multiplied maximum value	read-only
/api/slot/0/io/rtd	rtdValueScaled	RTD - scaled value	read-only
/api/slot/0/io/rtd	rtdValueScaledMin	RTD - minimum scaled value	read-only
/api/slot/0/io/rtd	rtdValueScaledMax	RTD - maximum scaled value	read-only
/api/slot/0/io/rtd	rtdResetMinValue	RTD - reset minimum value (1: RESET)	read-write
/api/slot/0/io/rtd	rtdResetMaxValue	RTD - reset maximum value (1: RESET)	read-write
/api/slot/0/io/rtd/0/rtdValueEngineeringMultiplied	rtdValueEngineeringMultiplied	RTD - engineering multiplied value	read-only
/api/slot/0/io/tc			
/api/slot/0/io/tc	tcIndex	TC - index	read-only
/api/slot/0/io/tc	tcSensorType	TC - sensor type	read-only
/api/slot/0/io/tc	tcValueEngineeringMultiplied	TC - engineering multiplied value	read-only
/api/slot/0/io/tc	tcValueEngineeringMultipliedMin	TC - engineering multiplied minimum value	read-only
/api/slot/0/io/tc	tcValueEngineeringMultipliedMax	TC - engineering multiplied maximum value	read-only
/api/slot/0/io/tc	tcValueScaled	TC - scaled value	read-only
/api/slot/0/io/tc	tcValueScaledMin	TC - minimum scaled value	read-only
/api/slot/0/io/tc	tcValueScaledMax	TC - maximum scaled value	read-only
/api/slot/0/io/tc	tcResetMinValue	TC - reset minimum value (1: RESET)	read-write
/api/slot/0/io/tc	tcResetMaxValue	TC - reset maximum value (1: RESET)	read-write
/api/slot/0/io/tc/0/tcValueEngineeringMultiplied	tcValueEngineeringMultiplied	TC - engineering multiplied value	read-only

Response Code

HTTP Status Code/ Description		Moxa Status Code/ Description		User Message
400	Bad Request	101	UnsupportedVersion	The content version specified in the request is not supported.
400	Bad Request	102	UnsupportedDocFormat	The document format specified in the request is not supported.
400	Bad Request	201	InvalidJsonFormat	The json format in the request is invalid.
400	Bad Request	202	InvalidNodeValue	One of the node values is invalid.
400	Bad Request	203	WrongChannelOrder	The I/O channels are disordered.
400	Bad Request	204	MissingRequiredChannel	A required channel index was not specified in the request body.
400	Bad Request	206	MissingRequiredNode	A required node was not specified in the request body.
400	Bad Request	300	ContentFailed	One of the channel contents in the request could not be set. Please refer to the detail information.
400	Bad Request	301	ContentFailedToSet	The content in the request could not be set. (invalid value)
200	OK	N/A		
404	Bad Request	N/A		
405	Method Not Allowed	N/A		
500	Internal Server Error	N/A		

D. Network Port Numbers

ioLogik E1200 Network Port Usage

Port	Type	Usage
68	UDP	BOOTP/DHCP
69	UDP	Export/import configuration file
80	TCP	Web console service
161	UDP	SNMP Agent
502	TCP	Modbus/TCP communication
2222	UDP	EtherNet/IP implicit message
4800	UDP	Auto search
9020	TCP	Peer-to-peer (default)
9200	TCP	ioLogik 2500's expansion
10124	TCP	Configuration port (ioSearch)
44818	TCP	EtherNet/IP explicit message

E. Factory Default Settings

ioLogik E1200 series products are configured with the following factory default settings:

Default IP address	192.168.127.254
Default Netmask	255.255.255.0
Default Gateway	0.0.0.0
Communication watchdog	Disable
Modbus/TCP Alive Check	On
Modbus/TCP Timeout Interval	60 sec
DI Mode	DI
Filter time	100 ms
Trigger for counter	Lo to Hi
Counter status	Stop
DO Mode	DO
DO Safe Status	Disable
Power on status	Disable
Low width for pulse	1 ms (1.5 s for relay)
Hi width for pulse	1 ms (1.5 s for relay)
Output pulses	0 (continuous)
DIO Mode	DO
AI Mode	Voltage
Scaling and Slop-Intercept	Disable
Password	N/A
Server Name	N/A
Server Location	N/A
AO Mode	Voltage
Scaling	Disable

F. Pinouts

Pin Assignment of Terminal Blocks

ioLogik E1210 (Top to Bottom) **ioLogik E1211** (Top to Bottom) **ioLogik E1212** (Top to Bottom) **ioLogik E1213** (Top to Bottom) **ioLogik E1214** (Top to Bottom)

1	COM 0	1		1	COM 0	1	COM 0	1	COM 0
2	DIO	2	DO0	2	DIO	2	DIO	2	DIO
3	DI1	3	DO1	3	DI1	3	DI1	3	DI1
4	DI2	4	DO2	4	DI2	4	DI2	4	DI2
5	DI3	5	DO3	5	DI3	5	DI3	5	DI3
6	GND	6	GND	6	GND	6	DI4	6	DI4
7	DI4	7	DO4	7	DI4	7	DI5	7	DI5
8	DI5	8	DO5	8	DI5	8	DI6	8	GND
9	DI6	9	DO6	9	DI6	9	DI7	9	RO_NO
10	DI7	10	DO7	10	DI7	10	GND	10	RO_C
11	COM 1	11		11	COM1	11	DO0	11	R1_NO
12	DI8	12	DO8	12	DIO0	12	DO1	12	R1_C
13	DI9	13	DO9	13	DIO1	13	DO2	13	R2_NO
14	DI10	14	DO10	14	DIO2	14	DO3	14	R2_C
15	DI11	15	DO11	15	DIO3	15	DIO0	15	R3_NO
16	GND	16	GND	16	GND	16	DIO1	16	R3_C
17	DI12	17	DO12	17	DIO4	17	DIO2	17	R4_NO
18	DI13	18	DO13	18	DIO5	18	DIO3	18	R4_C
19	DI14	19	DO14	19	DIO6	19	GND	19	R5_NO
20	DI15	20	DO15	20	DIO7	20	EXT	20	R5_C

ioLogik E1240 (Top to Bottom) **ioLogik E1241** (Top to Bottom) **ioLogik E1242** (Top to Bottom) **ioLogik E1260** (Top to Bottom) **ioLogik E1262** (Top to Bottom)

1	AI0+	1	VO0+	1	AI0+	1	EX0	1	TC0+
2	AI0-	2	VO0-	2	AI0-	2	IN0+	2	TC0-
3	AI1+	3	IO0+	3	AI1+	3	IN0-	3	TC1+
4	AI1-	4	IO0-	4	AI1-	4	EX1	4	TC1-
5	AI2+	5	VO1+	5	AI2+	5	IN1+	5	TC2+
6	AI2-	6	VO1-	6	AI2-	6	IN1-	6	TC2-
7	AI3+	7	IO1+	7	AI3+	7	EX2	7	TC3+
8	AI3-	8	IO1-	8	AI3-	8	IN2+	8	TC3-
9	AI4+	9	VO2+	9	COM0	9	IN2-	9	TC4+
10	AI4-	10	VO2-	10	DIO	10	EX3	10	TC4-
11	AI5+	11	IO2+	11	DI1	11	IN3+	11	TC5+
12	AI5-	12	IO2-	12	DI2	12	IN3-	12	TC5-
13	AI6+	13	VO3+	13	DI3	13	EX4	13	TC6+
14	AI6-	14	VO3-	14	GND	14	IN4+	14	TC6-
15	AI7+	15	IO3+	15	COM1	15	IN4-	15	TC7+
16	AI7-	16	IO3-	16	DIO0	16	EX5	16	TC7-
17		17		17	DI01	17	IN5+	17	
18		18		18	DI02	18	IN5-	18	
19		19	EX_V	19	DI03	19		19	
20		20	EX_C	20	GND	20		20	



NOTE

EX_V: External Voltage

EX_C: External Com

G. FCC Interference Statement

Federal Communication Commission Warning!

This equipment has been tested and found to comply with the limits for a Class A digital device, pursuant to part 15 of the FCC Rules. Operation is subject to the following two conditions: (1) This device may not cause harmful interference, and (2) this device must accept any interference received, including interference that may cause undesired operation.

These limits are designed to provide reasonable protection against harmful interference when the equipment is operated in a commercial environment. This equipment generates, uses, and can radiate radio frequency energy and, if not installed and used in accordance with the instruction manual, may cause harmful interference to radio communications. Operation of this equipment in a residential area is likely to cause harmful interference in which case the user will be required to correct the interference at his own expense.

H. European Community (CE)

This is a Class A product. In a domestic environment, this product may cause radio interference in which case the user may be required to take adequate measures.

I. Firmware Update Guidelines

To prevent system failure, take the following steps when updating the firmware.

Step 1: Click on the following link to open the Support & Downloads page on Moxa's website. Type the name of the model, click Search, and then click the hyperlink of the specific model whose firmware you would like to update.

Link: http://www.moxa.com/support/support_home.aspx?isSearchShow=1

Support & Downloads



Please choose a model :

• [ioLogik E1210](#)

Step 2: Click on **Software Packages** hyperlink in the Software box, and then download the latest software package.

ioLogik E1210

Documentation <ul style="list-style-type: none">• Datasheets• Manuals	Software <ul style="list-style-type: none">• Firmware• Libraries• Software Packages• Utilities	FAQs <ul style="list-style-type: none">• Other	Other <ul style="list-style-type: none">• Product Page
---	--	---	---

Software package for ioLogik E1200 Series

Edition 1.0
Released on Jan 11, 2017

[Details and release notes](#)

> [Download 47 MB](#)

Step 3: Click the **Details and release notes** hyperlink, and then download the **Release History**, which contains a detailed list of all software, including all released versions.

Software package for ioLogik E1200 Series
Edition 1.0
Released on Jan 11, 2017
[Details and release notes](#)
> Download 47 MB

Software package for ioLogik E1200 Series

Software package for ioLogik E1200 Series (47 MB)
Edition 1.0
Release on 2017-01-11
[Download](#)

▶ **For the following product(s):**

ioLogik E1210
ioLogik E1211
ioLogik E1212
ioLogik E1213
ioLogik E1214
ioLogik E1240
ioLogik E1241
ioLogik E1242
ioLogik E1260
ioLogik E1262

▶ **Release Notes:**

[V1.0]

[New Feature\(s\)](#)

1. Software Package first release

[Note\(s\)](#)

1. All versions of firmware are included in the software package

▶ **Release History** : [File Download](#)

Step 4: To upgrade or downgrade the firmware, look up the software package release note and inspect the version release sequence one-by-one. For example, if you want to downgrade the ioLogik E1210's firmware from V2.4 to V2.0, the sequence is **V2.4 > V2.3 > V2.2 > V2.0**. If you would like to upgrade from V1.6 to V2.0, the sequence is **V1.6 > V1.8 > V1.9 > V2.0**.



NOTE

If you do not follow the correct upgrade or downgrade sequence, the device may not operate properly, or could even crash.

Product	Version	Build Date
ioLogik E1210	V1.2	2009-09-15
	V1.3	2010-06-23
	V1.4	2011-01-28
	V1.6	2011-03-10
	V1.8	2011-09-29
	V1.9	2011-11-24
	V2.0	2013-04-15
	V2.2	2014-12-12
	V2.3	2015-03-10
	V2.4	2016-05-30
	V2.5	2016-09-12

